



ABC # 113

28ft x 5 shel f TEQUILA & VODKA



-12

0

12

24

36

48

60



ABC # 113

28ft x 5 shel f TEQUILA & VODKA

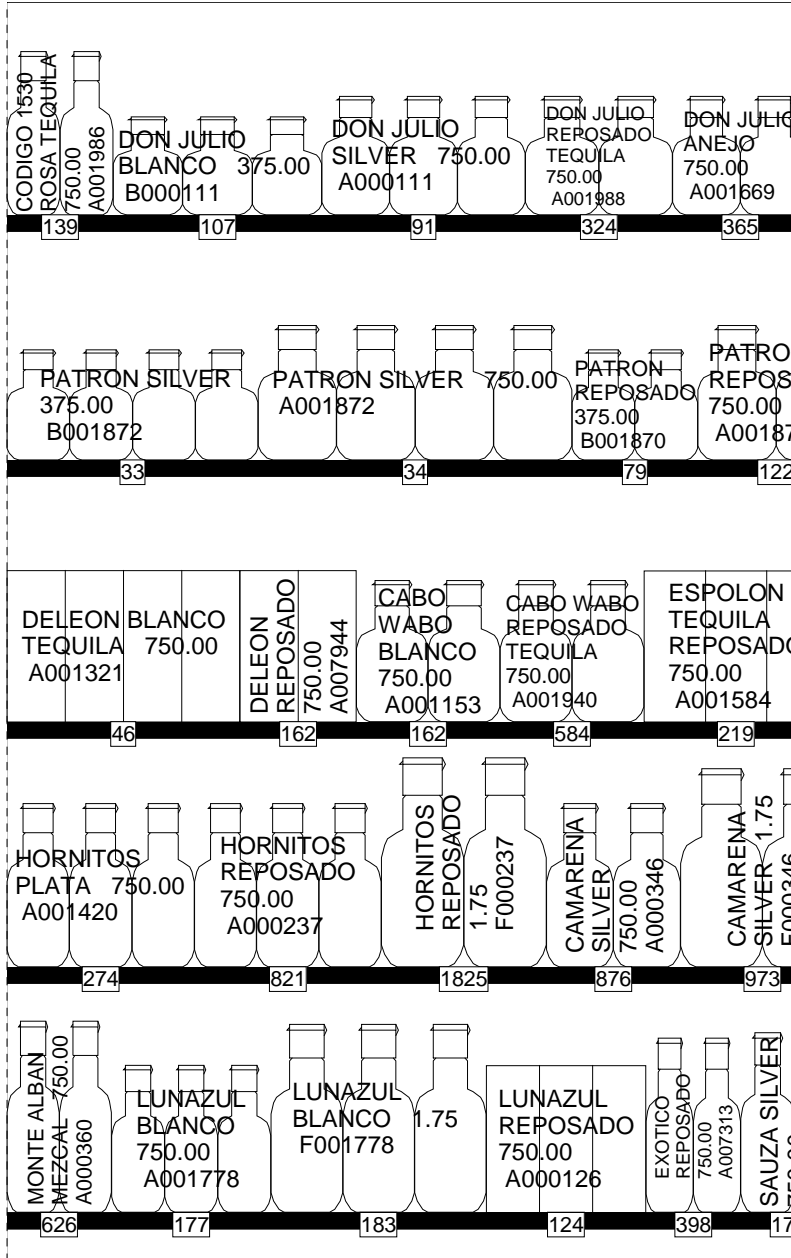

-12 0 12 24 36 48 60



ABC # 113

28ft x 5 shel f TEQUILA & VODKA



36

48

60

72

84

96

108



ABC # 113

28ft x 5 shel f TEQUILA & VODKA

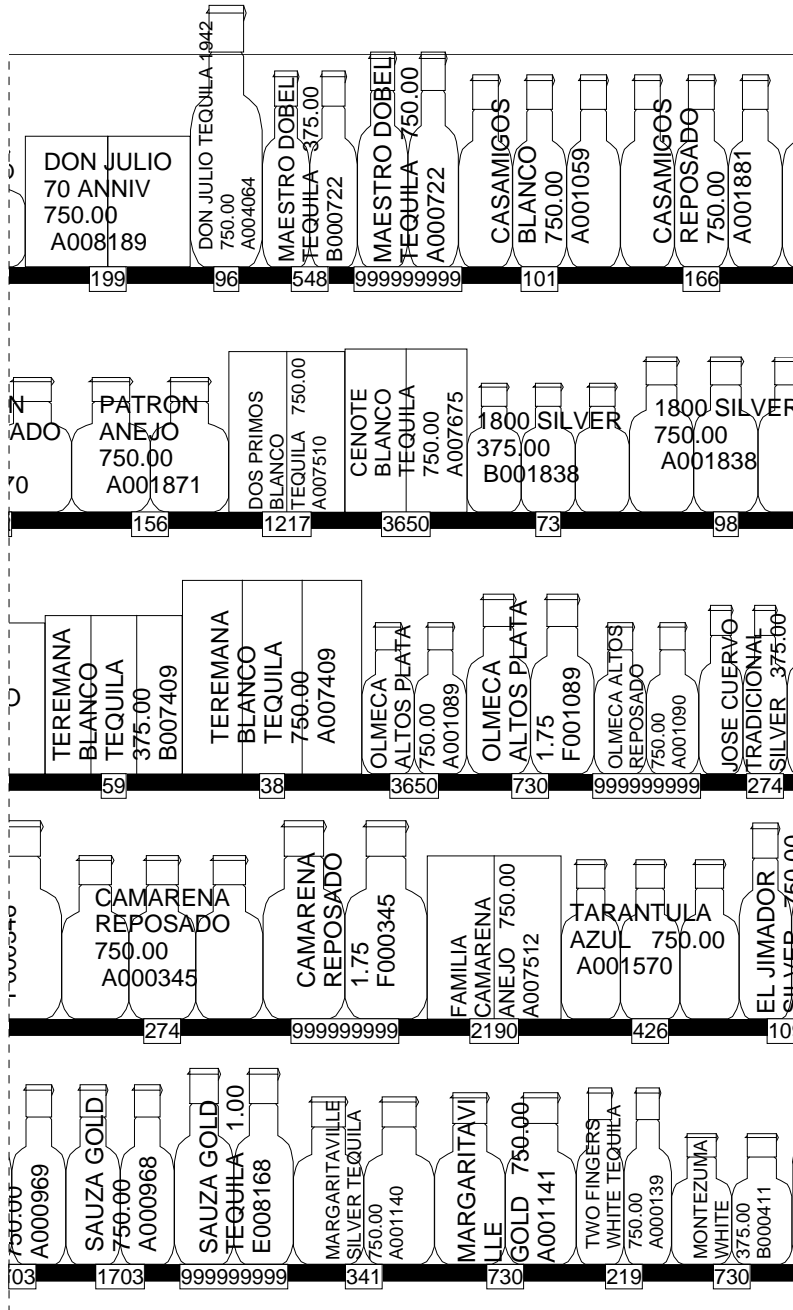

36

48

60

72

84

96

108

3/7/2024



ABC # 113

28ft x 5 shel f TEQUILA & VODKA



84

96

108

120

132

144

156



ABC # 113

28ft x 5 shel f TEQUILA & VODKA

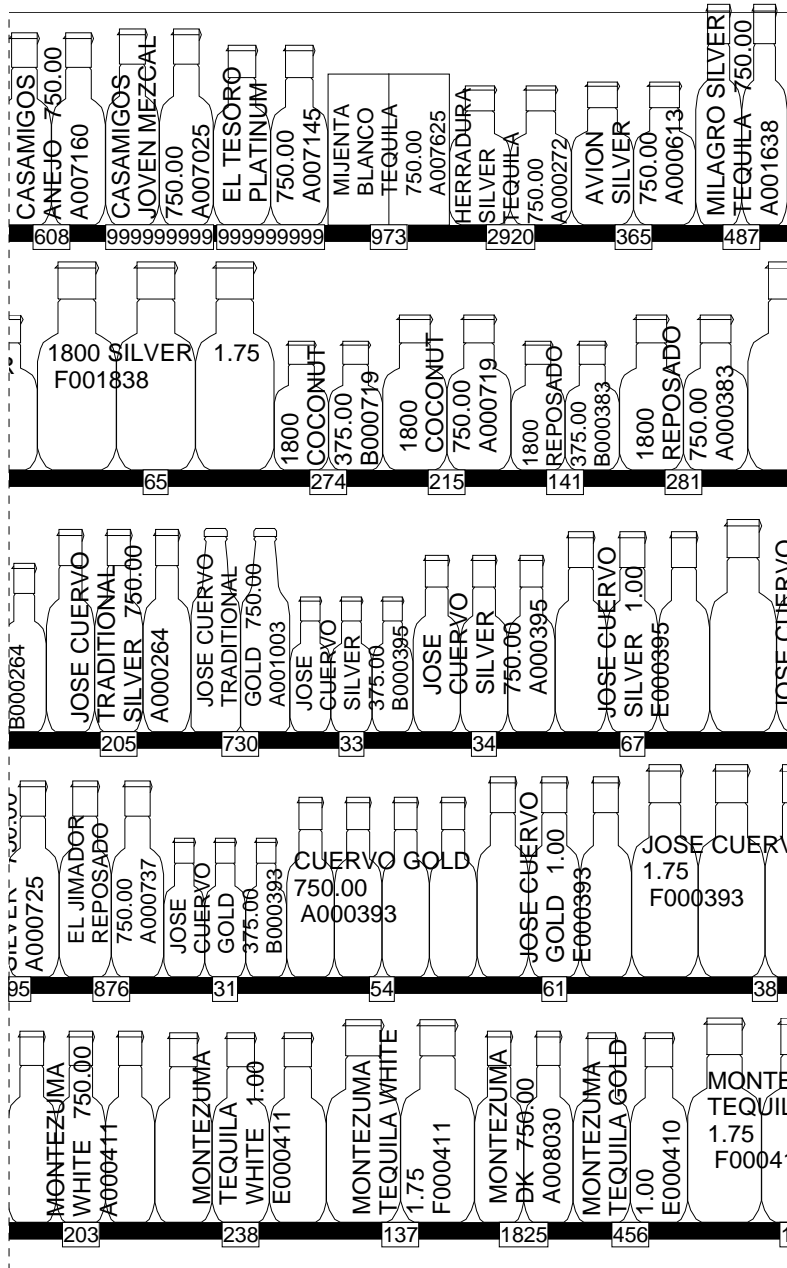

84

96

108

120

132

144

156



ABC # 113

28ft x 5 shel f TEQUILA & VODKA



132

144

156

168

180

192

204



ABC # 113

28ft x 5 shel f TEQUILA & VODKA



180

192

204

216

228

240

252



ABC # 113

28ft x 5 shel f TEQUILA & VODKA

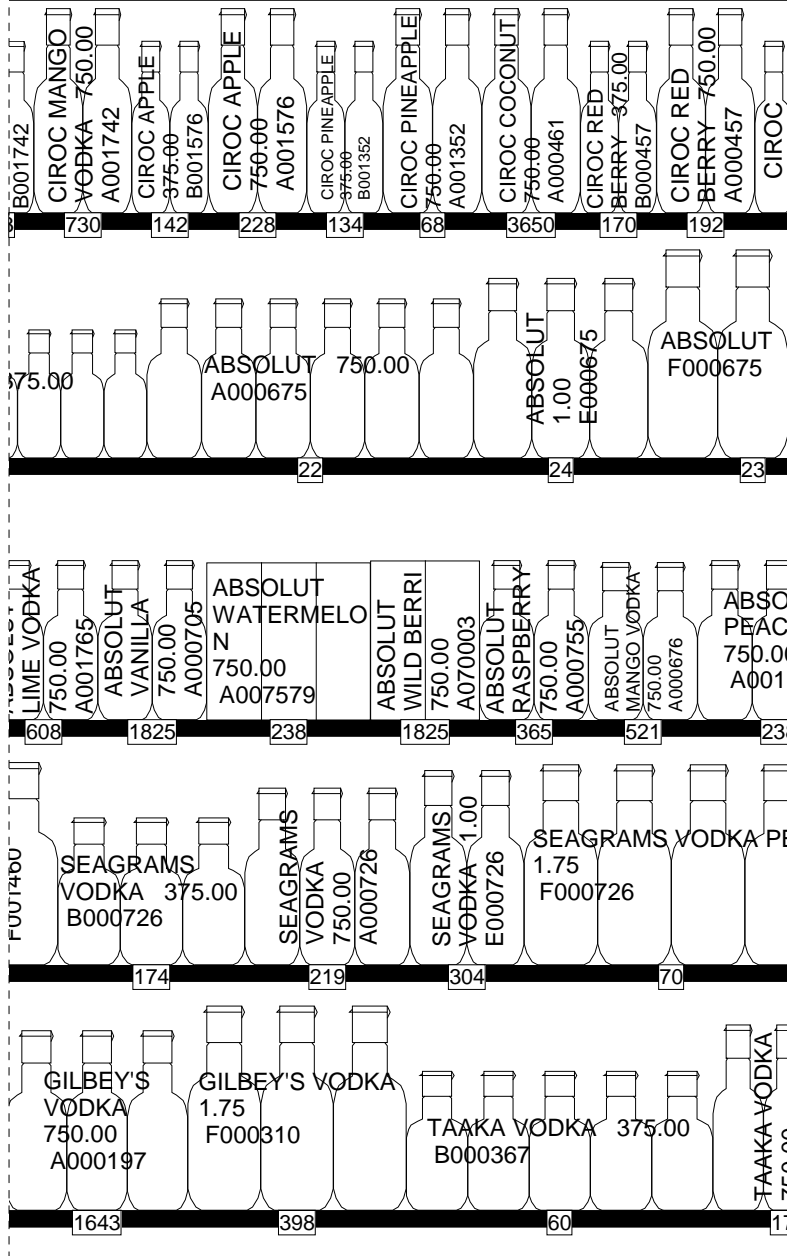

180 192 204 216 228 240 252



ABC # 113

28ft x 5 shel f TEQUILA & VODKA



228

240

252

264

276

288

300



ABC # 113

28ft x 5 shel f TEQUILA & VODKA

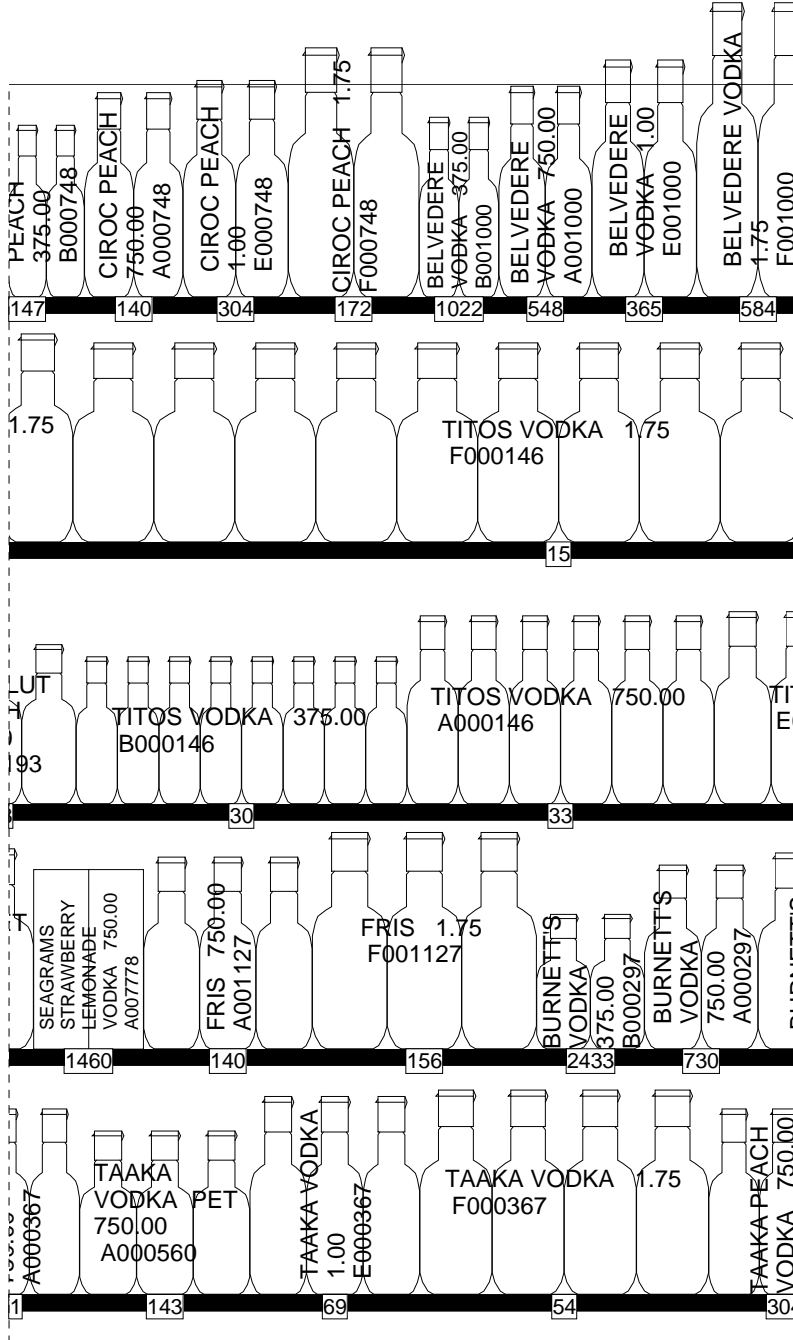

228 240 252 264 276 288 300



ABC # 113

28ft x 5 shel f TEQUILA & VODKA



276 288 300 312 324 336 348



ABC # 113

28ft x 5 shel f TEQUILA & VODKA

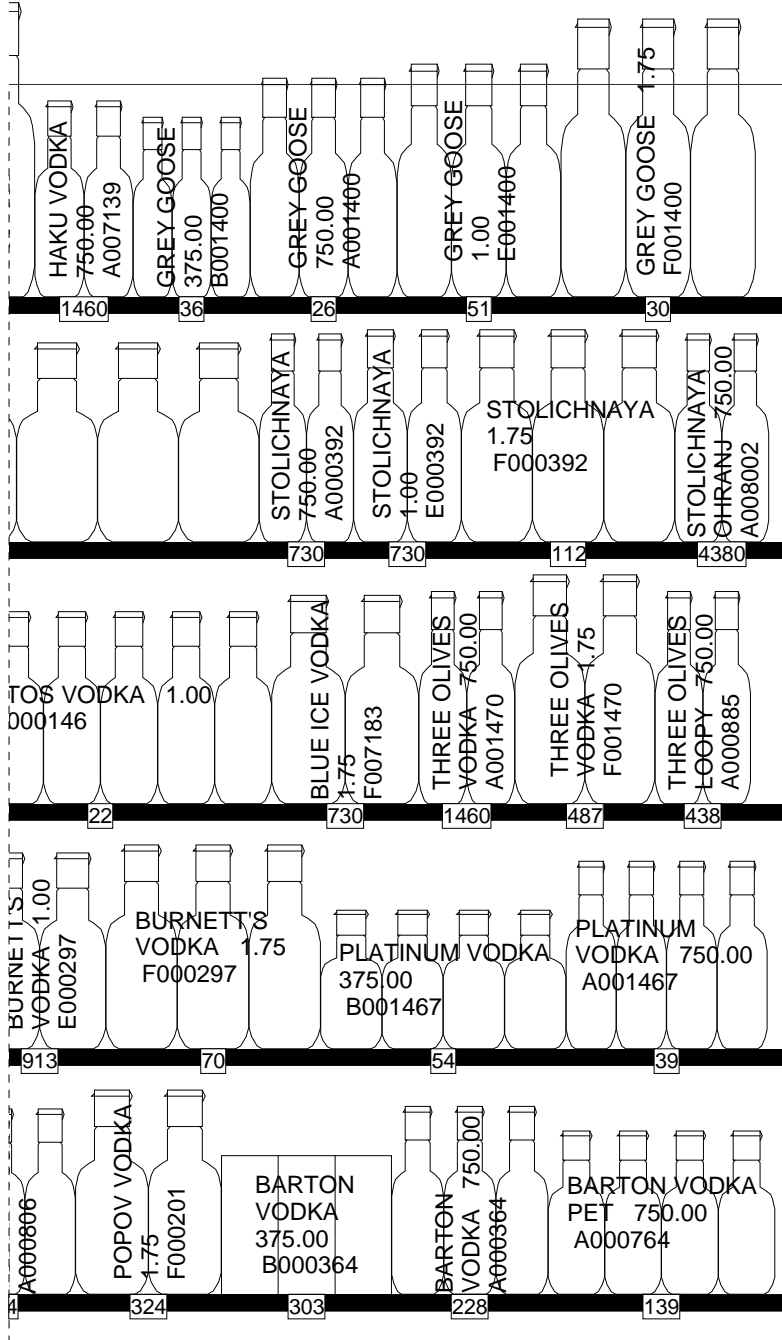

276 288 300 312 324 336 348



ABC # 113

35ft x 5 shel f VODKA WRAPPED & AMERICAN WHISKEY



-12 0 12 24 36 48 60



ABC # 113

35ft x 5 shel f VODKA
WRAPPED & AMERICAN

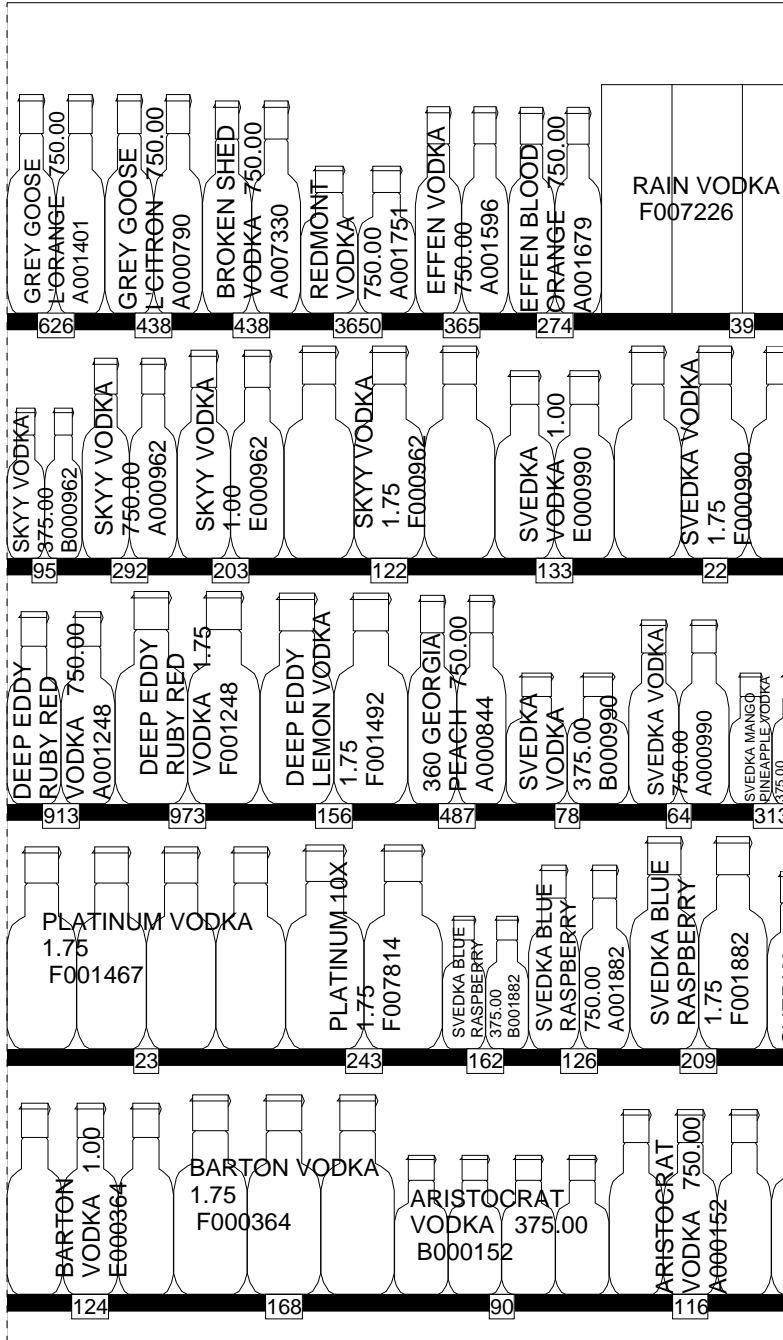

-12 0 12 24 36 48 60



ABC # 113

35ft x 5 shel f VODKA WRAPPED & AMERICAN WHISKEY





ABC # 113

35ft x 5 shel f VODKA
WRAPPED & AMERICAN

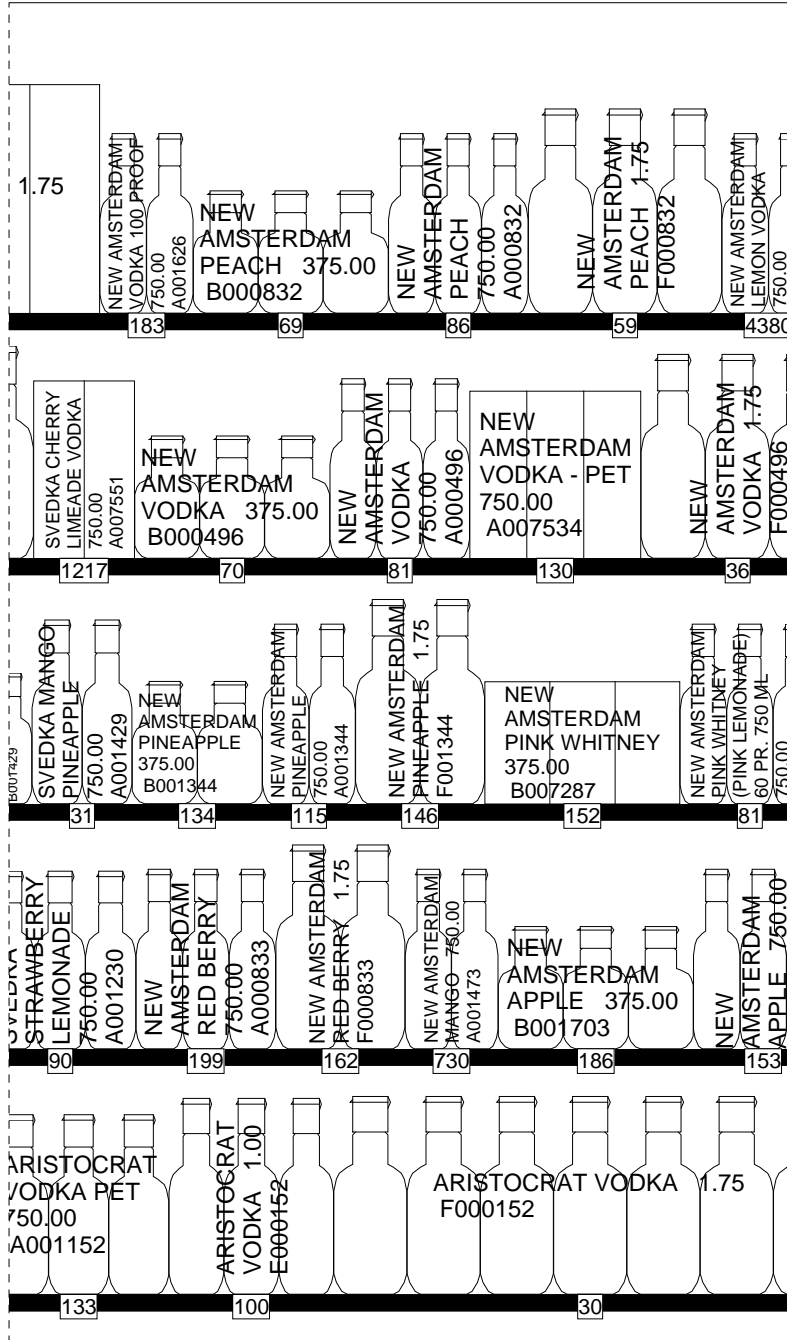

36

48

60

72

84

96

108

3/7/2024



ABC # 113

35ft x 5 shel f VODKA WRAPPED & AMERICAN WHISKEY

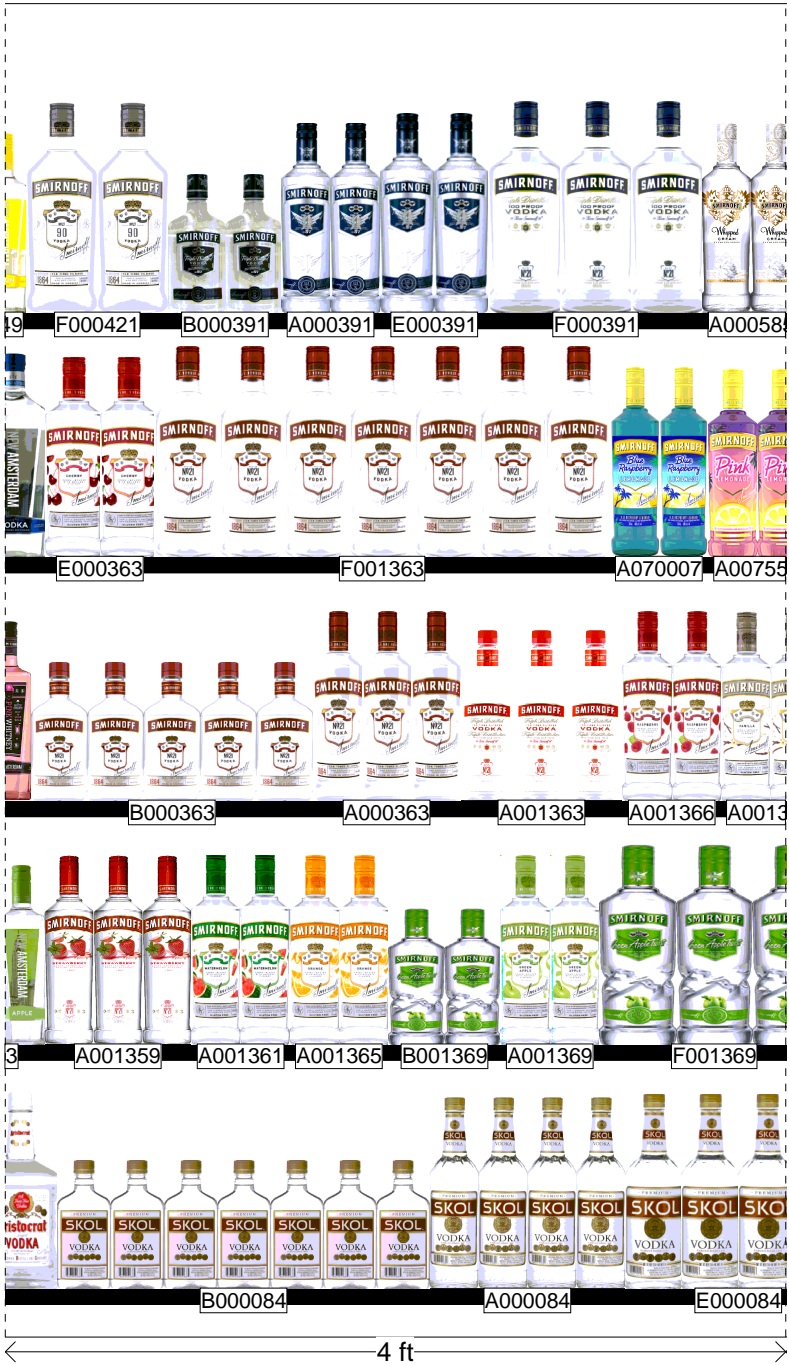

F000421 B000391 A000391 E000391 F000391 A000581
 E000363 F001363 A070007 A007581
 B000363 A000363 A001363 A001366 A001369
 A001359 A001361 A001365 B001369 A001369 F001369
 B000084 A000084 E000084

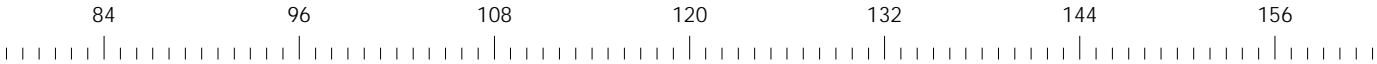



ABC # 113

35ft x 5 shel f VODKA
WRAPPED & AMERICAN

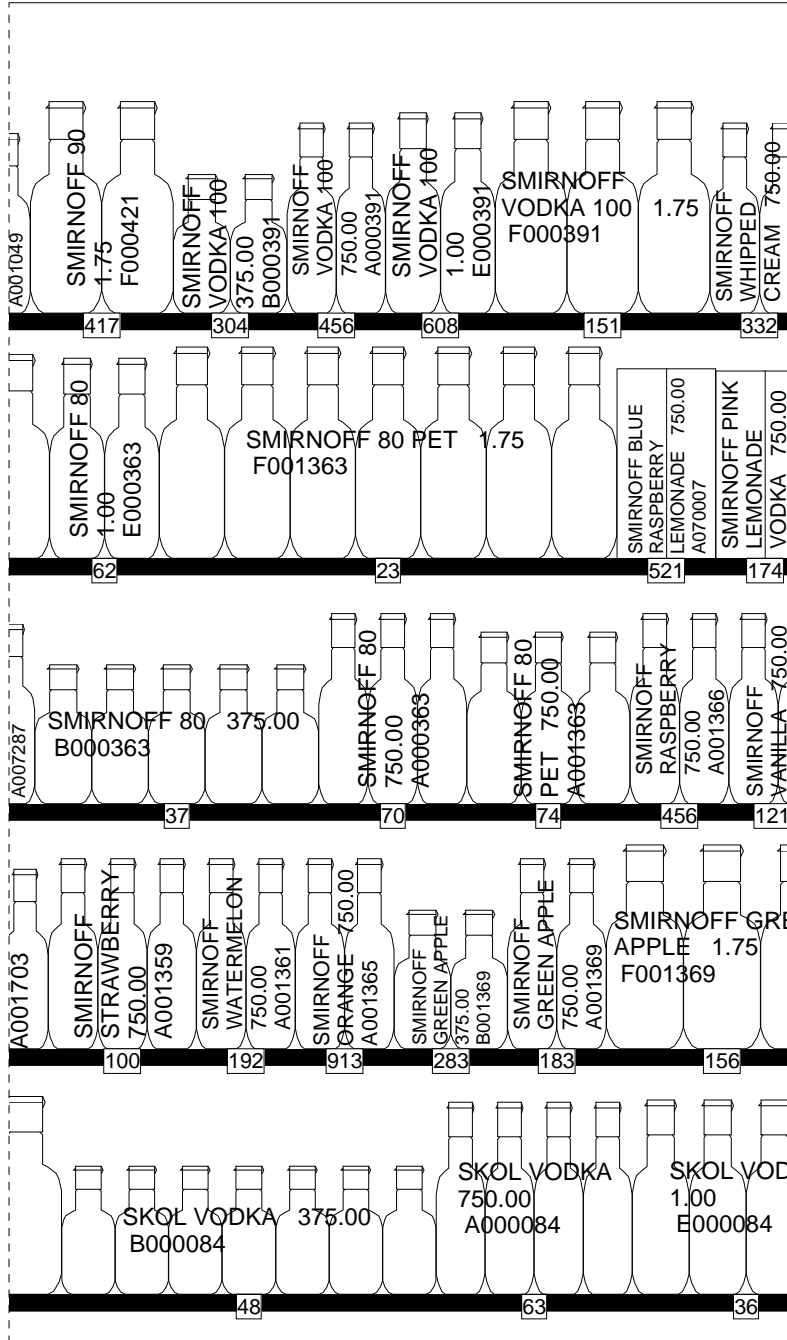

84 96 108 120 132 144 156



ABC # 113

35ft x 5 shel f VODKA WRAPPED & AMERICAN WHISKEY



132

144

156

168

180

192

204



ABC # 113

35ft x 5 shel f VODKA
WRAPPED & AMERICAN

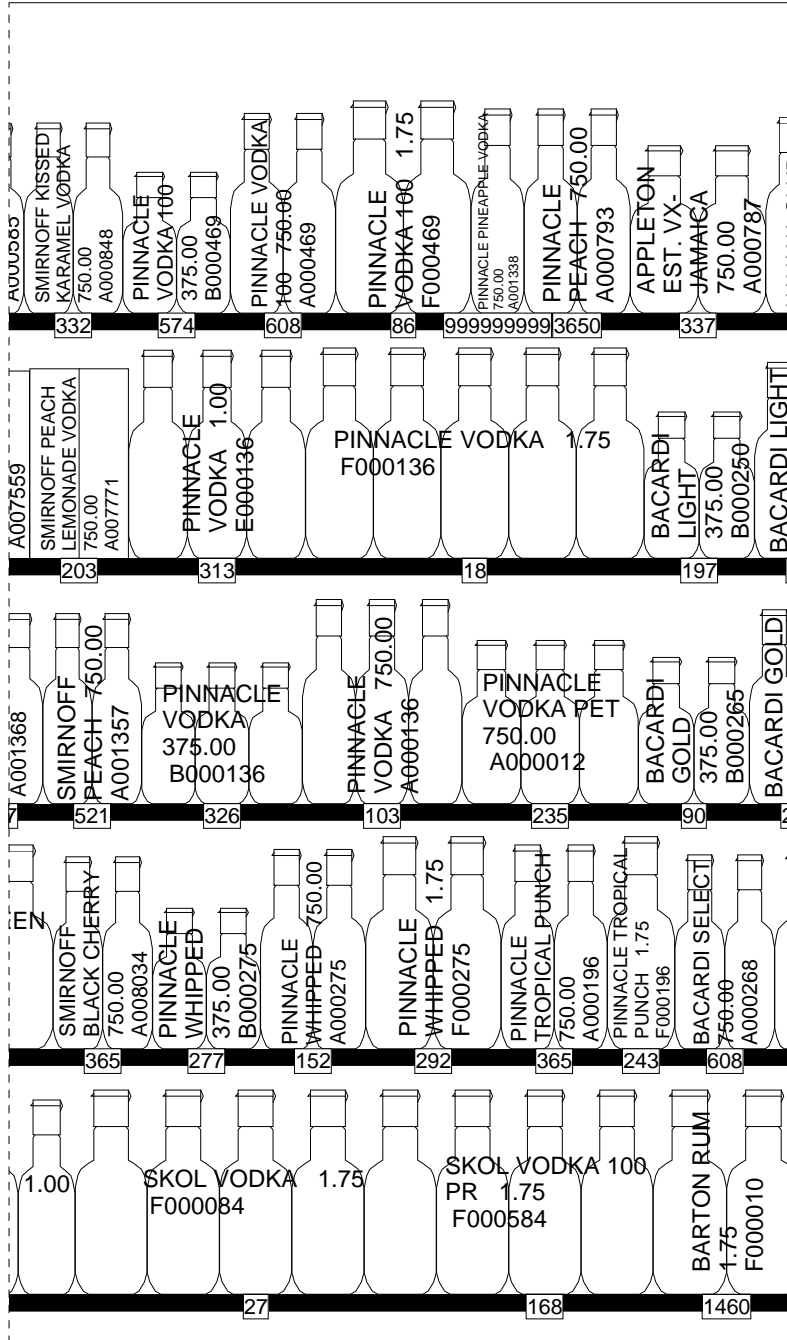

132 144 156 168 180 192 204



ABC # 113

35ft x 5 shel f VODKA WRAPPED & AMERICAN WHISKEY



180

192

204

216

228

240

252



ABC # 113

35ft x 5 shel f VODKA
WRAPPED & AMERICAN

750.00 A001676	750.00 A001980	750.00 A001888	750.00 A007261	750.00 A001446	750.00 A007293	750.00 A007370	750.00 A000380
1825	548	3650	1095	999999999	999999999	3650	
750.00 A000250	750.00 A001850	750.00 E000250	750.00 F000250	1.75L F001850	1.75L F001850	375.00 B000659	
66	531	243	61	62		205	
750.00 A000265	750.00 A001265	750.00 E000265	750.00 F000265	1.75L F001265	1.75L F001265	750.00 A001659	
61	487	608	137	91		177	
750.00 A001044	750.00 F001044	750.00 A007138	750.00 A000995	750.00 A000910	750.00 A001634		
5475	999999999	999999999	1095	456	999999999		
1.00 E000137	1.75L F000137	1.75L F000054	1.75L F000054	750.00 A001251			
456	1095	313	2190				

180

192

204

216

228

240

252

3/7/2024



ABC # 113

35ft x 5 shel f VODKA WRAPPED & AMERICAN WHISKEY



228

240

252

264

276

288

300



ABC # 113

35ft x 5 shel f VODKA
WRAPPED & AMERICAN

DIPLOMATICO MANTUANO RUM 750.00 A007307	KIRK & SWEENEY 12YR RUM 750.00 A001753	KIRK & SWEENEY 18 YR. D. REPUBLIC 750.00 A001754	BUMBU RUM 750.00 A001935	BUMBU XO BLACK 750.00 A007263	SAILOR SPICE 750.00 B0007
3650	199	548	127	3650	
MALIBU COCONUT 750.00 A00659	MALIBU COCONUT PET 750.00 A00652	MALIBU COCONUT 1.00 F00659	MALIBU COCONUT F00659	1.75	RUMHAVEN RUM 750.00 A001087
63	183	83	57	4380	CAPTAIN
MALIBU MANGO RUM 750.00 A001658	MALIBU WATERMELON RUM 750.00 A007583	MALIBU BLACK 750.00 A000658	BLUE CHAIR RUM 750.00 A000993	BLUE CHAIR BAY SPICED RUM 750.00 A007142	BLUE CHAIR BANANA RUM 750.00 A001533
304	608	406	548	1217	3650
PARROT BAY COCONUT- PET 750.00 A001402	PARROT BAY 90 PROOF- PET 750.00 A000181	PARROT BAY PINEAPPLE PET 750.00 A001161	CRUZAN COCONUT RUM 750.00 A000898	CRUZAN MANGO RUM 750.00 A000926	CRUZAN
505	3285	597	304	304	
ASTILLO SILVER RUM 750.00 A000251	CASTILLO GOLD RUM 1.75 F000252	CRUZAN LIGHT RUM 750.00 A000906	CRUZAN LIGHT RUM 1.75 F000906	CRUZAN DARK RUM 750.00 A000408	
209	876	684	999999999	1825	

228

240

252

264

276

288

300

3/7/2024



ABC # 113

35ft x 5 shel f VODKA WRAPPED & AMERICAN WHISKEY



276

288

300

312

324

336

348



ABC # 113

35ft x 5 shel f VODKA WRAPPED & AMERICAN WHISKEY



324

336

348

360

372

384

396



ABC # 113

35ft x 5 shel f VODKA
WRAPPED & AMERICAN

JIM BEAM BLACK 1.75 F000662	JIM BEAM DEVILS CUT 750.00 A000660	JIM BEAM RYE 750.00 A000634	LARCENY BOURBON 750.00 A001810	BALCONES POT STILL BOURBON
209	876	1095	958	97
PET 750.00 A000198	JIM BEAM BOURBON 1.00 E000664	JIM BEAM BOURBON F000664	JIM BEAM PET 1.75 F000198	WILD TURKEY 101 FLASK 375.00 B000453
165	70	32	25	321
WILD TURKEY 101 750.00				14
JIM BEAM RED STAG 750.00 A001889	JIM BEAM PEACH WHISKEY 750.00 A007121	JIM BEAM APPLE 375.00 B001528	JIM BEAM APPLE 750.00 A001528	JIM BEAM ORANGE 750.00 A007544
152	782	2008	521	1217
WILD TURKEY 81 FLASK 375.00 B000055				167
JIM BEAM HONEY 750.00 A000922	JIM BEAM HONEY 750.00 A000922	JIM BEAM HONEY 1.75 F000922	JIM BEAM KENTUCKY FIRE 750.00 A001337	WILD TURKEY AMERICAN HONEY 375.00 B000107
574	203	999999999	1095	105
WILD TURKEY AMERICAN HONEY 750.00				113
CLUB 400 BLEND 750.00 A000570	CLUB 400 BLEND 1.00 E000570	CLUB 400 BLEND 1.75 F000570	HEAVEN HILL 375.00 B000413	HEAVEN HILL 750.00 A000413
1217	456	243	94	38

324

336

348

360

372

384

396

3/7/2024



ABC # 113

35ft x 5 shel f VODKA WRAPPED & AMERICAN WHISKEY

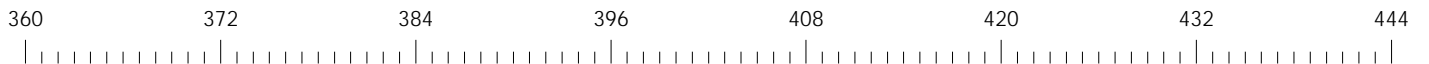



ABC # 113

35ft x 5 shel f VODKA
WRAPPED & AMERICAN

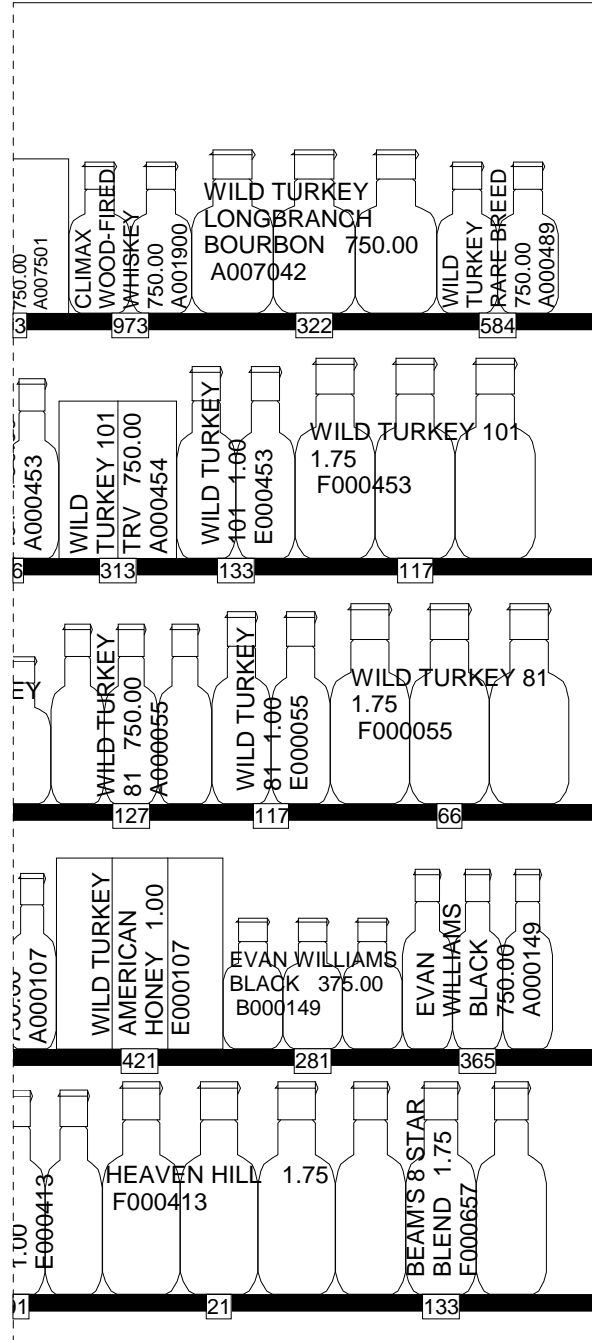

360 372 384 396 408 420 432 444



ABC # 113

23ft x 5 shel f AMERICAN & IRISH WHISKEY WRAPPED & SCOTCH

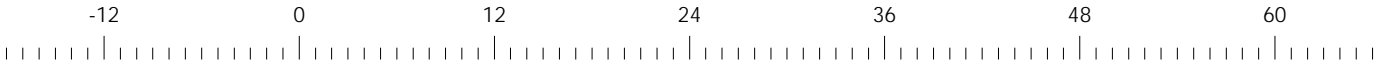



ABC # 113

23ft x 5 shel f AMERICAN & IRISH WHISKEY WRAPPED &

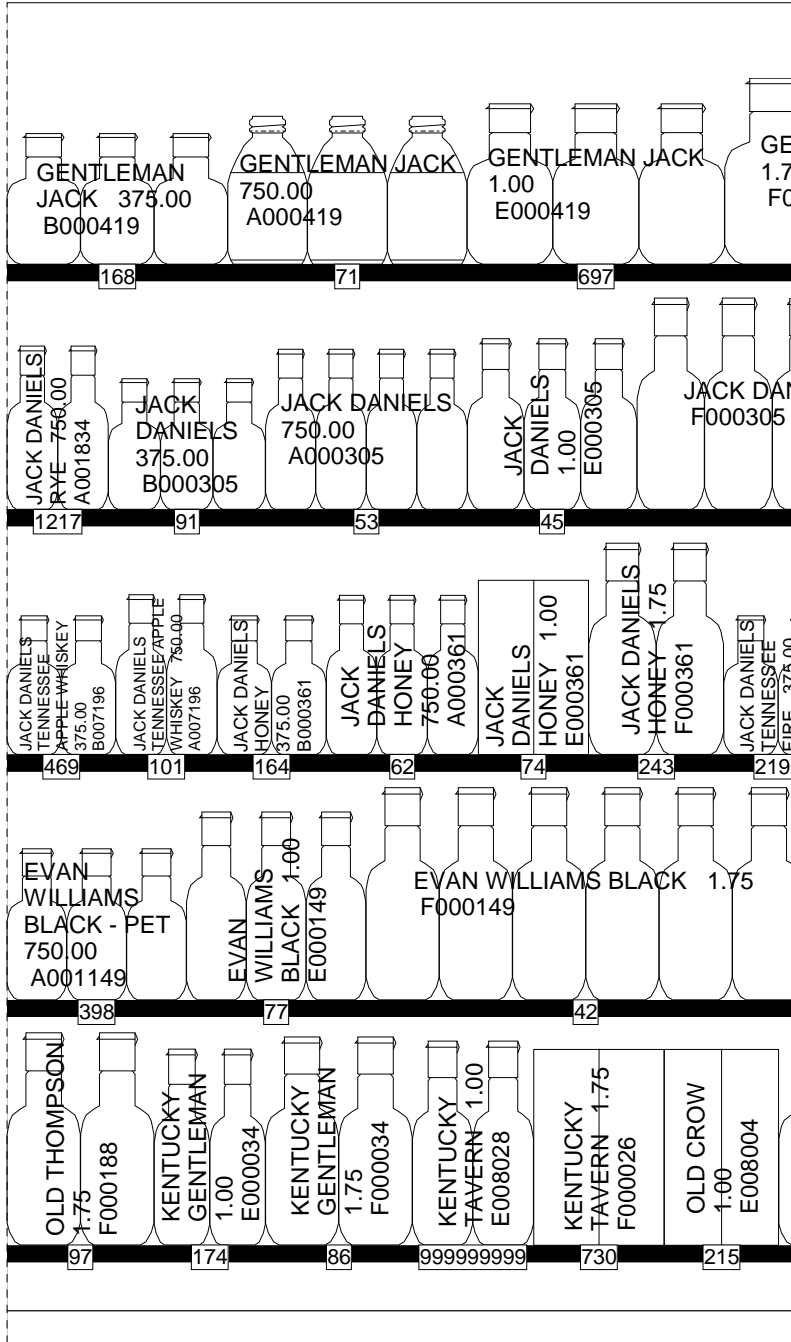

-12 0 12 24 36 48 60



ABC # 113

23ft x 5 shel f AMERICAN & IRISH WHISKEY WRAPPED & SCOTCH



36

48

60

72

84

96

108



ABC # 113

23ft x 5 shel f AMERICAN & IRISH WHISKEY WRAPPED &

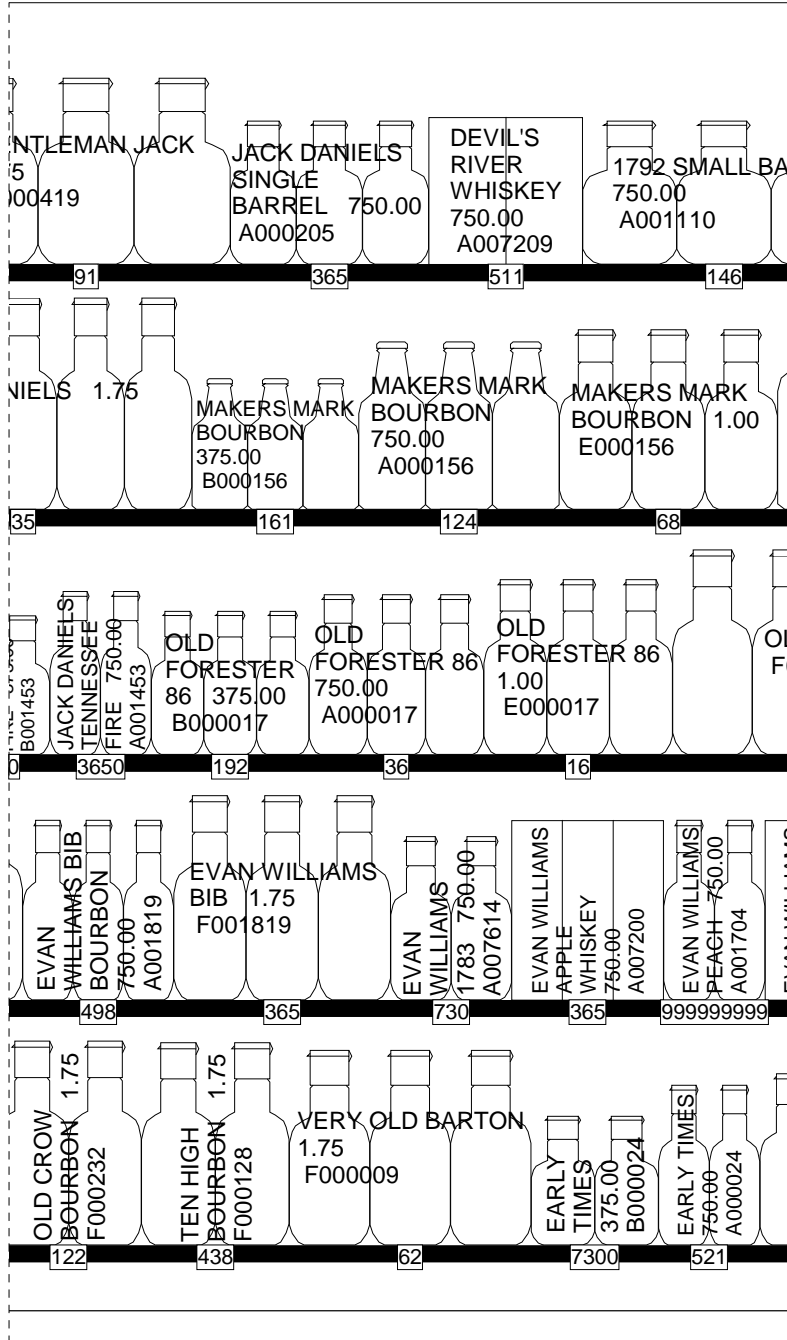

36

48

60

72

84

96

108

3/7/2024



ABC # 113

23ft x 5 shel f AMERICAN & IRISH WHISKEY WRAPPED & SCOTCH



84

96

108

120

132

144

156



ABC # 113

23ft x 5 shel f AMERICAN & IRISH WHISKEY WRAPPED &

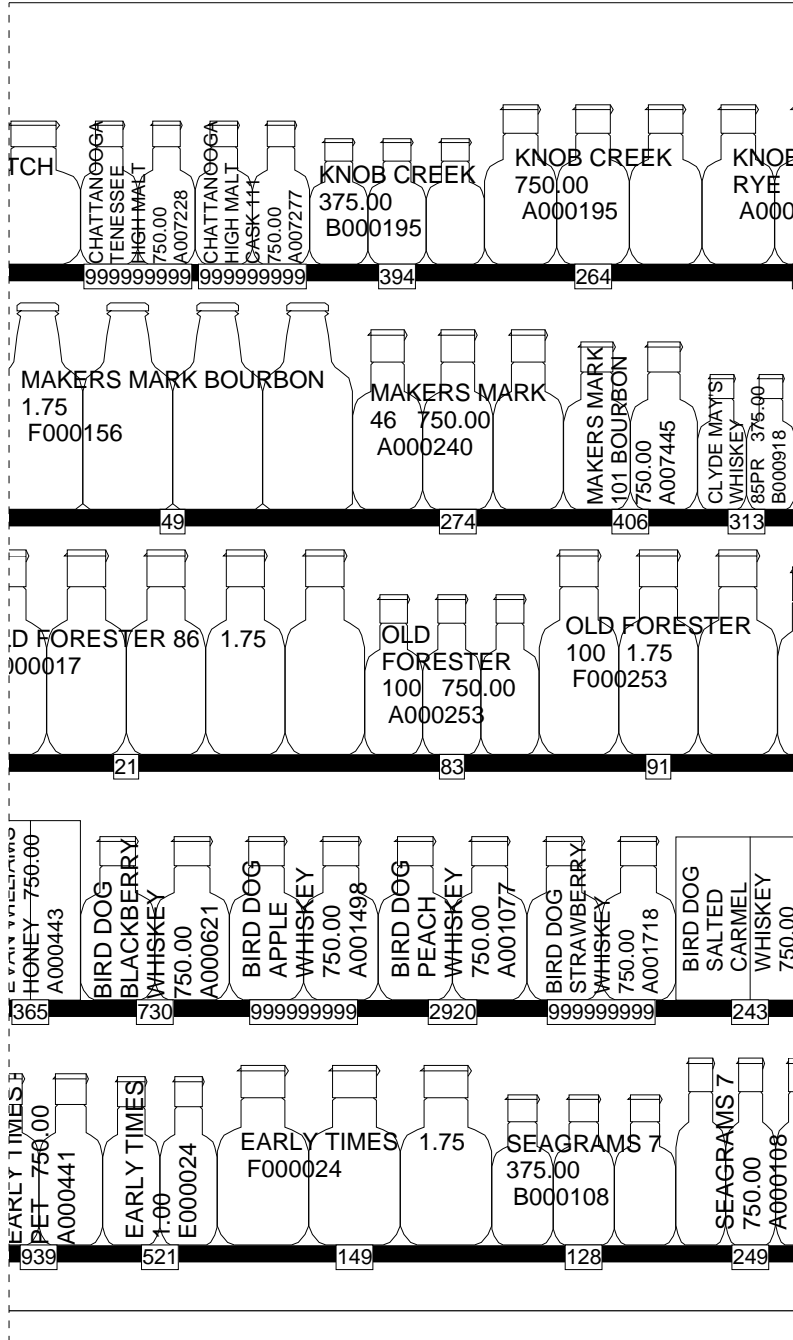

84

96

108

120

132

144

156

3/7/2024



ABC # 113

23ft x 5 shel f AMERICAN & IRISH WHISKEY WRAPPED & SCOTCH



132

144

156

168

180

192

204



ABC # 113

23ft x 5 shel f AMERICAN & IRISH WHISKEY WRAPPED &

3 CREEK 750.00 742	YELLOWSTONE WHISKEY 750.00 A005877	TEMPLETON RYE 6 YR. 750.00 A001720	BROTHERS BOND BOURBON 750.00 A007662	BASIL HAYDEN 750.00 A000194	BASIL HAYDEN DARK RYE
451	469	521	498	124	124
CLYDE MAY'S WHISKEY 85PR 750.00 A000918	CLYDE MAY'S BOURBON 92PR 750.00 A001700	CLYDE MAY'S RYE WHISKEY 750.00 A007215	WOODFORD RESERVE 375.00 B001515	WOODFORD RESERVE	
137	487	313	378		
OLD FORESTER 1870 BIB 750.00 A001500	OLD CAMP PEACH-PECAN WHISKEY 750.00 A001709	FOUR ROSES YELLOW LABEL 750.00 A000556	FOUR ROSES YELLOW LABEL 1.75 F000556	OLD TUB WHISKEY 750.00 A007363	BERNHEIM STRAIGHT 750.00 A000937
406	608	140	2190	999999999	548
A007600	BIRD DOG PEANUT BUTTER 750.00 A007735	BIRD DOG HONEY 750.00 A007854	OLE SMOKEY BLENDED WHISKEY 750.00 A001779	OLE SMOKY SALTY WATERMELON WHISKEY 750.00 A007161	OLE SMOKY PEANUT BUTTER WHISKEY 750.00 A007446
	1947	5840	999999999	2920	999999999
SEAGRAMS 7 PET 750.00 A000143	SEAGRAMS 7 1.00 E000108	SEAGRAMS 7 1.75 F000108		ANCIENT AGE 750.00 A000153	
451	322	33		3650	

132

144

156

168

180

192

204

3/7/2024



ABC # 113

23ft x 5 shel f AMERICAN & IRISH WHISKEY WRAPPED & SCOTCH



180 192 204 216 228 240 252



ABC # 113

23ft x 5 shel f AMERICAN & IRISH WHISKEY WRAPPED &

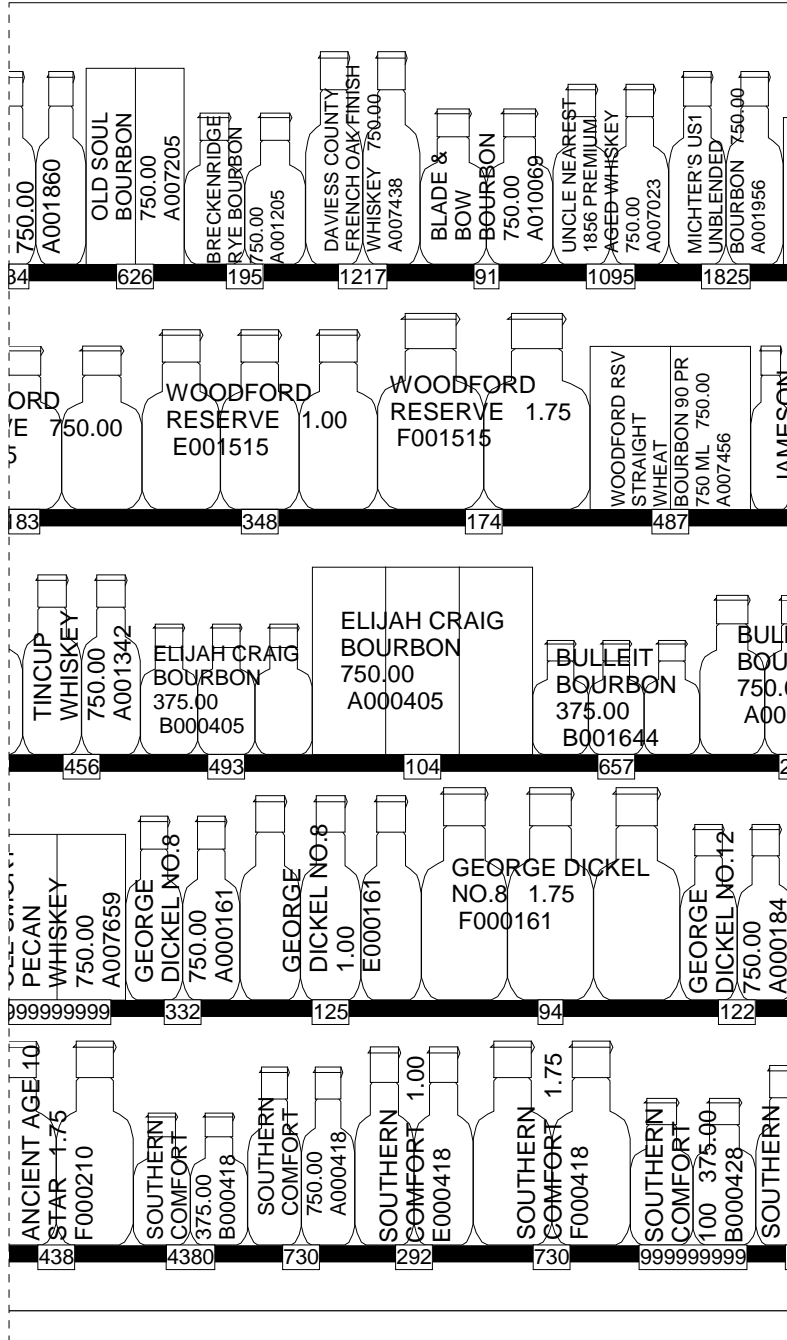

180 192 204 216 228 240 252



ABC # 113

23ft x 5 shel f AMERICAN & IRISH WHISKEY WRAPPED & SCOTCH



216 228 240 252 264 276 288 300



ABC # 113

23ft x 5 shel f AMERICAN & IRISH WHISKEY WRAPPED &

CHICKEN COCK STRAIGHT BOURBON 750.00 A007506	CHICKEN COCK STRAIGHT RYE WHISKEY 750.00 A007822	PADDY'S IRISH WHISKEY 750.00 A001061	BUSHMILLS IRISH 750.00 A000633	BUSHMILLS BLACK BUSH 750.00 A001630
9999999999	9999999999	1217	1095	4380
JAMESON 750.00 A000547	JAMESON 1.00 E000547	JAMESON 1.75 F000547		
145	62	159	151	
BULLEIT BOURBON 750.00 A000751	BULLEIT BOURBON 1.75 F001644	BULLEIT RYE 375.00 B000751	BULLEIT RYE 750.00 A000751	
99	168	505	274	
GEORGE DICKEL NO.12 1.00 E000184	GEORGE DICKEL NO.12 1.75 F000184	EZRA BROOKS 90 750.00 A001671	EZRA BROOKS 99 750.00 A007511	
65	64	3650	406	
COMFUR 750.00 A000428	OLD GRANDDAD 750.00 A000234	VIRGIN BOURBON 750.00 A000300	REBEL YELL BOURBON 750.00 A001886	REBEL YELL BOURBON 100PR 750.00 A007201
825	1095	9999999999	1460	324

216 228 240 252 264 276 288 300



ABC # 113

12ft x 5 shel f CANADIAN WHISKEY

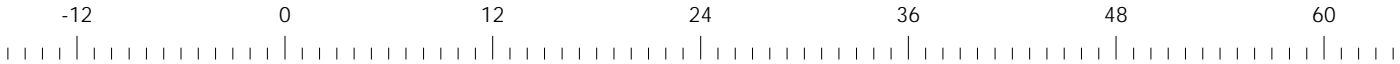



ABC # 113

12ft x 5 shel f CANADIAN WHISKEY

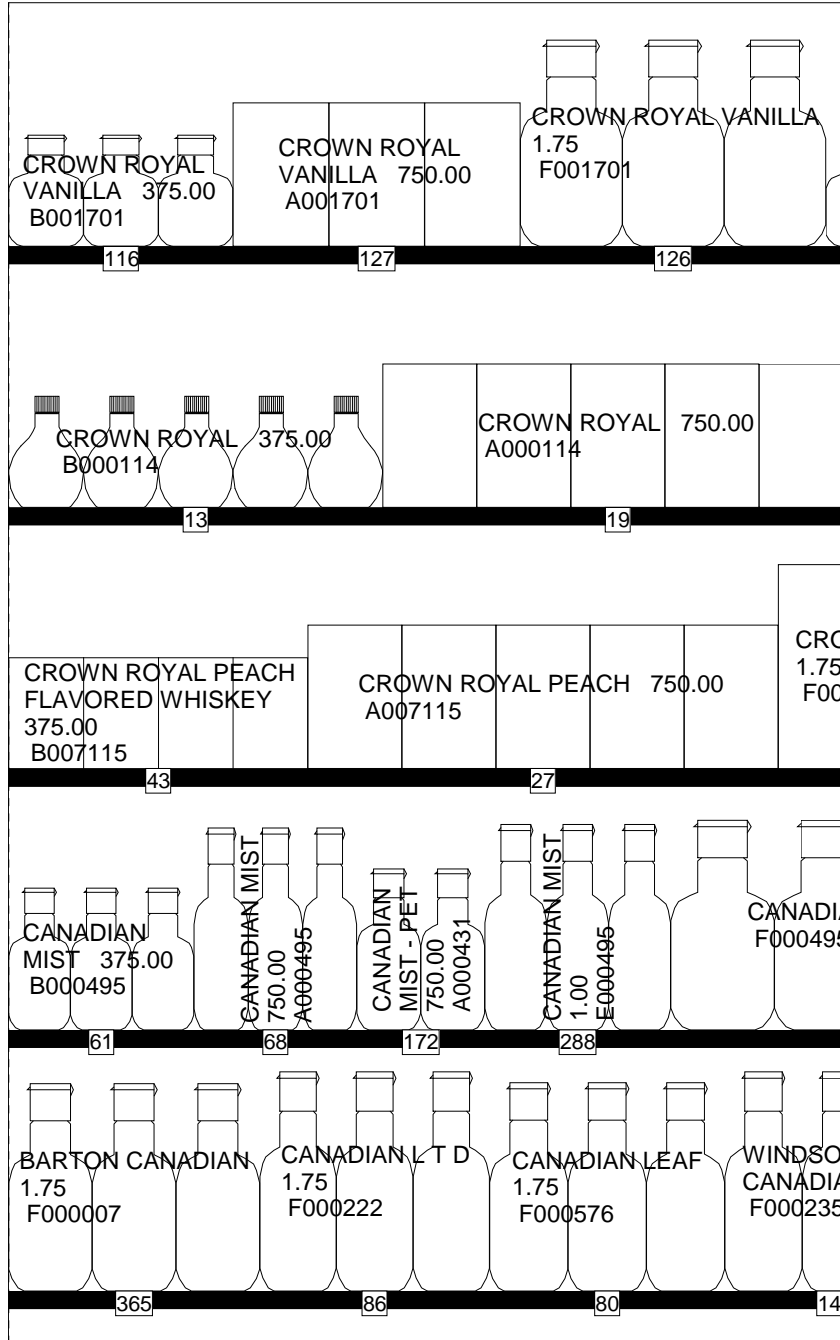



ABC # 113

12ft x 5 shel f CANADIAN WHISKEY



36

48

60

72

84

96

108



ABC # 113

12ft x 5 shel f CANADIAN WHISKEY

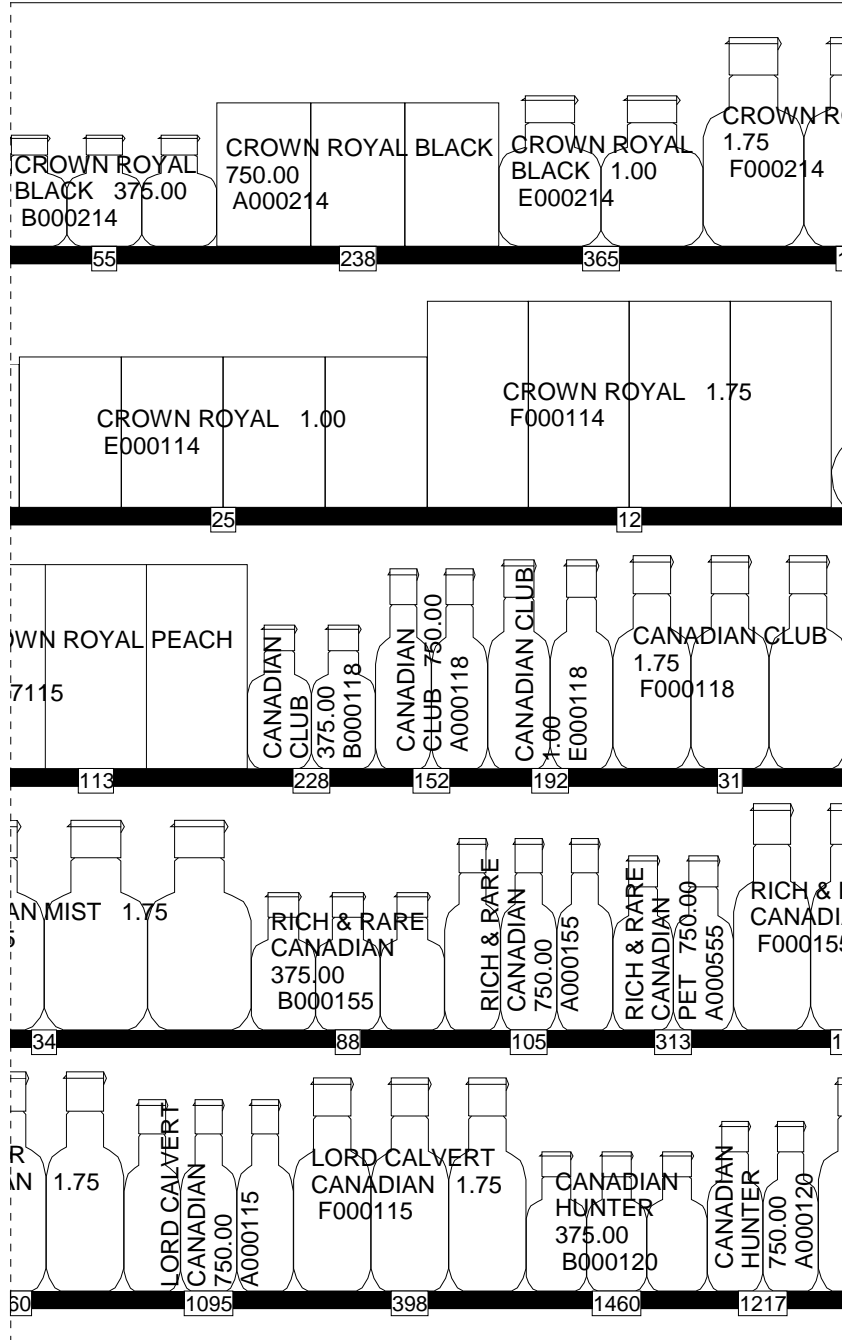

36

48

60

72

84

96

108

3/7/2024



ABC # 113

12ft x 5 shel f CANADIAN WHISKEY

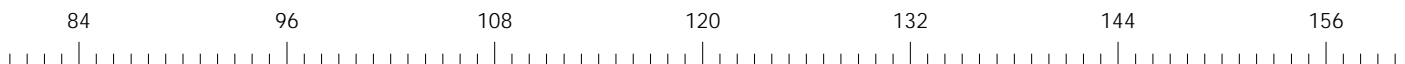



ABC # 113

12ft x 5 shel f CANADIAN WHISKEY

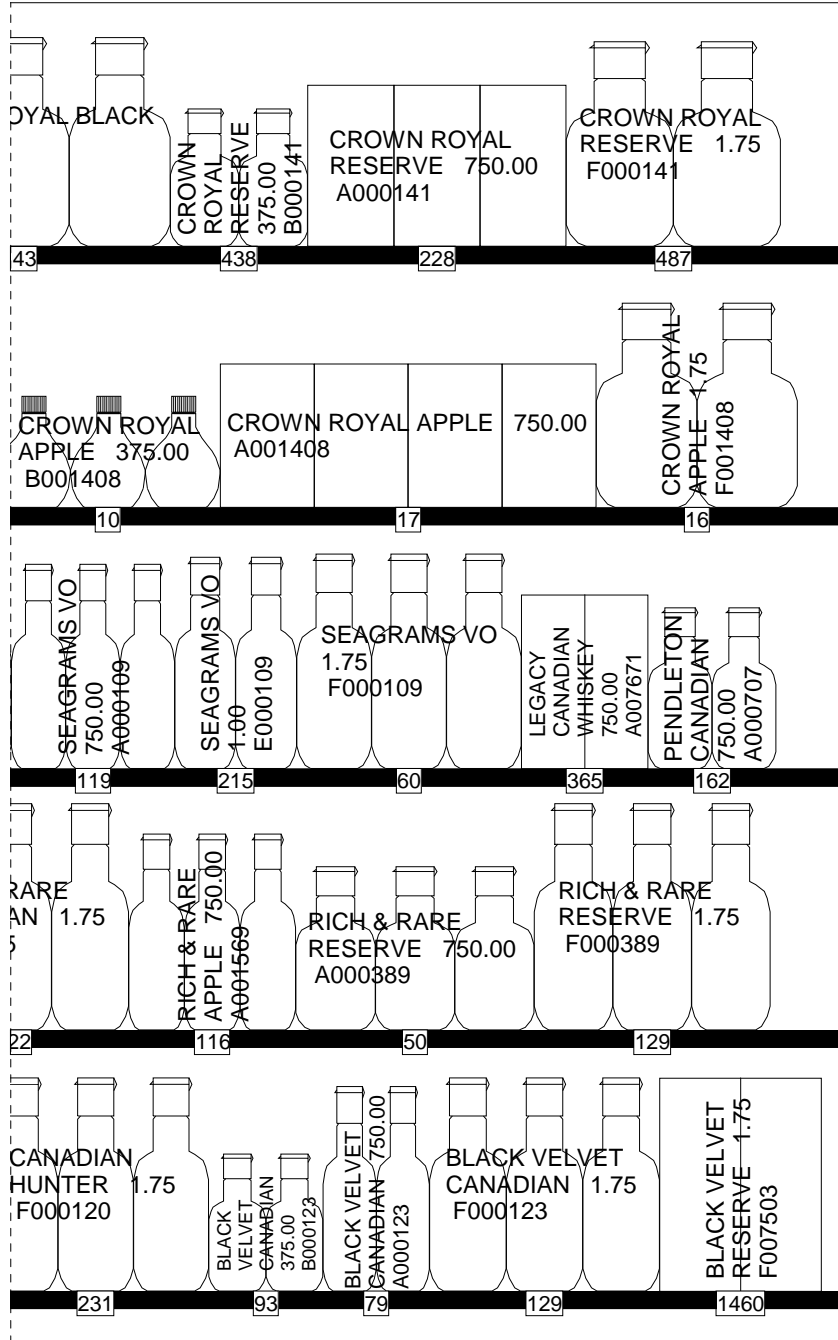

84

96

108

120

132

144

156

3/7/2024



ABC # 113

16ft x 3 shel f COCKTAILS



0 12 24 36 48



ABC # 113

16ft x 3 shel f COCKTAILS

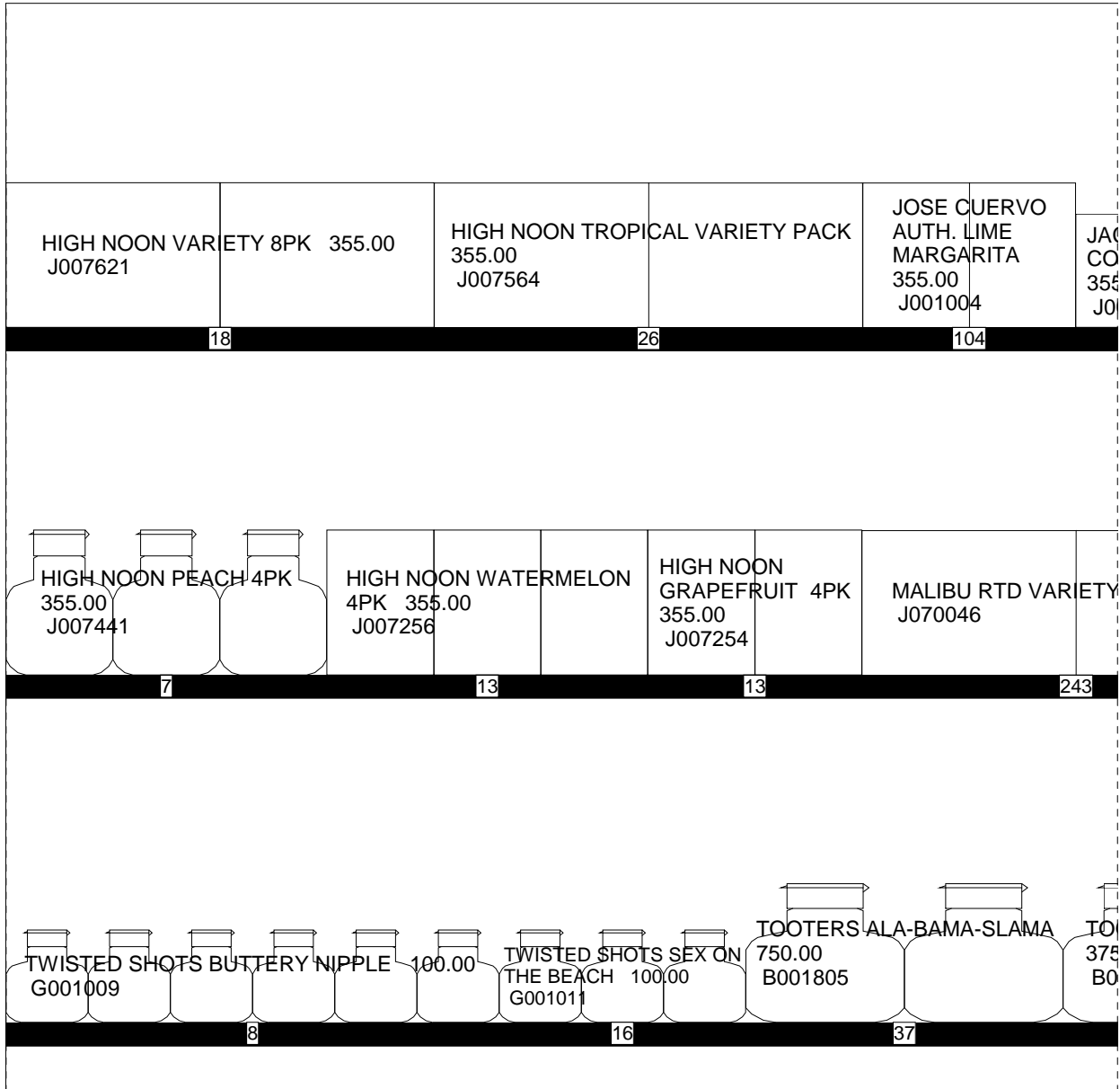

0

12

24

36

48

3/7/2024

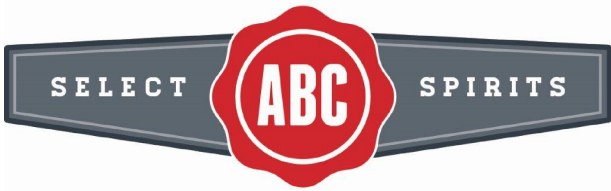

ABC # 113

16ft x 3 shel f COCKTAILS



4 ft

48 60 72 84 96



ABC # 113

16ft x 3 shel f COCKTAILS

<p>CK DANIELS & ICA COLA RTD 4PK 5.00 07943</p>	<p>CROWN ROYAL RTD COLA 4PK 355.00 J007555</p>	<p>CROWN ROYAL RTD APPLE 4PK 355.00 J007557</p>	<p>HARD ICE PINA COLADA - CAN 200.00 C007144</p>	<p>HARD ICE PARTY PEACH RTD 200.00 C007410</p>	<p>HARD ICE BLUE BULLET 200.00 C007232</p>	<p>HARD ICE WATERMELON HEAD 200.00 C007233</p>	<p>HARD ICE STRAWBERRY DREAMSICLE RTD 200.00 C007411</p>	<p>JOSE CUERVO GOLDEN MARGARITA</p>
91	66	183	73	999999999	37	183	52	4
<p>8 PK 355.00</p>	<p>CROWN ROYAL RTD PEACH 4PK 355.00 J007556</p>	<p>CROWN ROYAL RTD LEMONADE 4PK 355.00 J007797</p>	<p>JOSE CUERVO RTD AUTH MARGARITA SINGL 200.00 C001004</p>	<p>JOSE CUERVO RTD AUTH STRAWBERRY MARG SINGLE 200.00 C001204</p>	<p>JOSE CUERVO AUTH PINK LEMONADE MARGARITA 200.00 C001609</p>	<p>JOSE CUERVO AUTH LIME - PET 375.00 B001004</p>	<p>JOSE CUERVO AUTH</p>	
	104	183	2	15	2	25		
<p>OTERS ON THE BEACH 5.00 01788</p>	<p>CHI CHI'S PINEAPPLE MARG SINGLE 200.00 C001611</p>	<p>CHI CHI'S MARGARITA 1.75 F000219</p>	<p>CHI CHI'S RUBY RED GRAPEFRUIT - SINGLE 200.00 C001495</p>	<p>CHI CHI'S RUBY RED MARGARITA 1.75 F001495</p>	<p>SALVADOR'S MARGARITA 1.75 F000280</p>			
66	16	29	19	73		10		

48

60

72

84

96

3/7/2024



ABC # 113

16ft x 3 shel f COCKTAILS



206 F001206 F001485 F007790 F001451 F000799



D1004 F001004 F001005 B001204 F001204 F007587 F007791



F000568 F007754 F001643 E000462 F000462 F001418

4 ft

96

108

120

132

144



ABC # 113

16ft x 3 shel f COCKTAILS

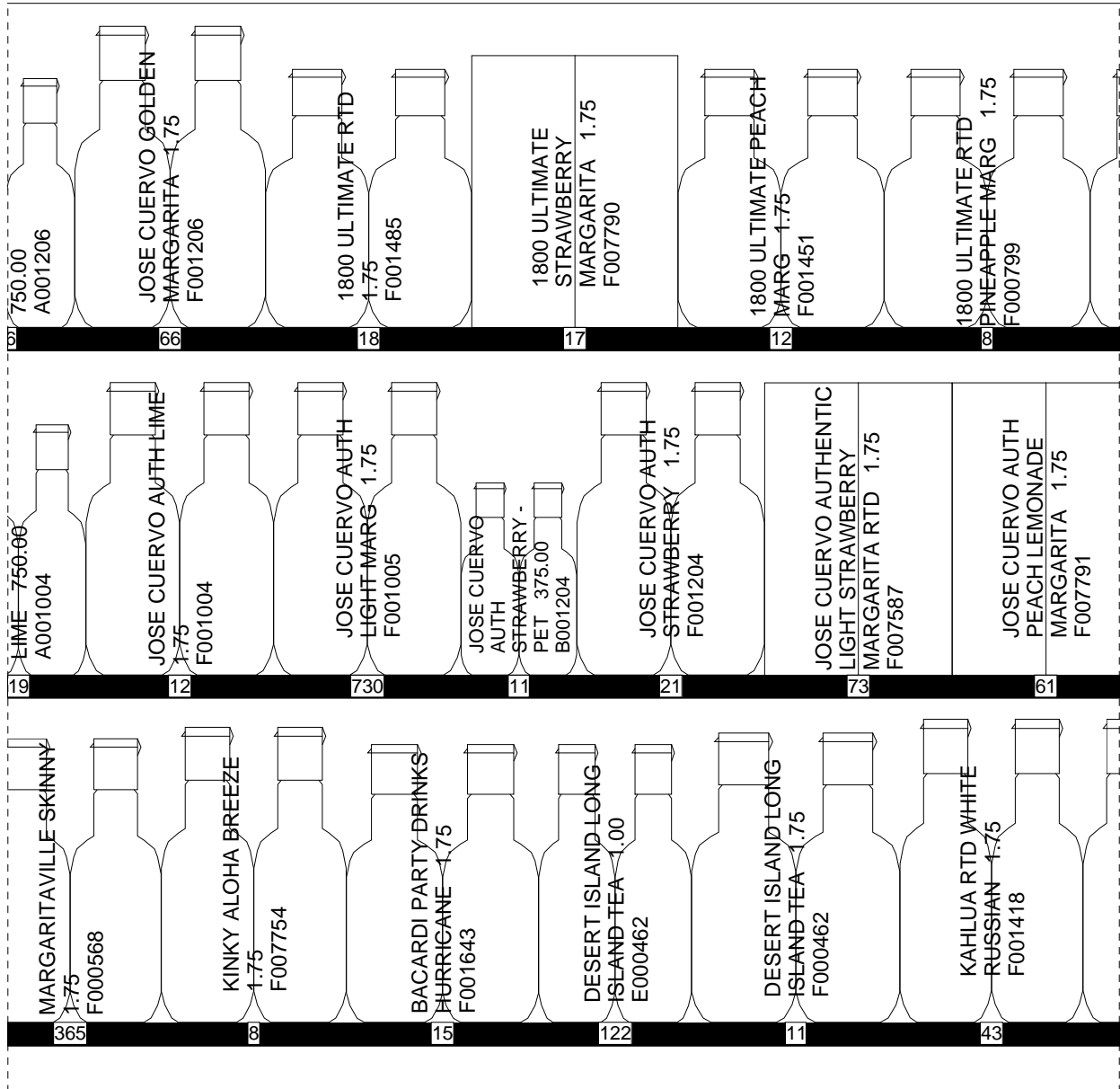

96

108

120

132

144

3/7/2024



ABC # 113

16ft x 3 shel f COCKTAILS

FRONT



F007169 F001968 F001618 F007389 B007746 B007749



F001223 F000289 F001609 A000562 A001423 F001423



F001417 F007170 F007390 F000502 F001427 F000749

4 ft

144 156 168 180 192



ABC # 113

16ft x 3 shel f COCKTAILS

FRONT

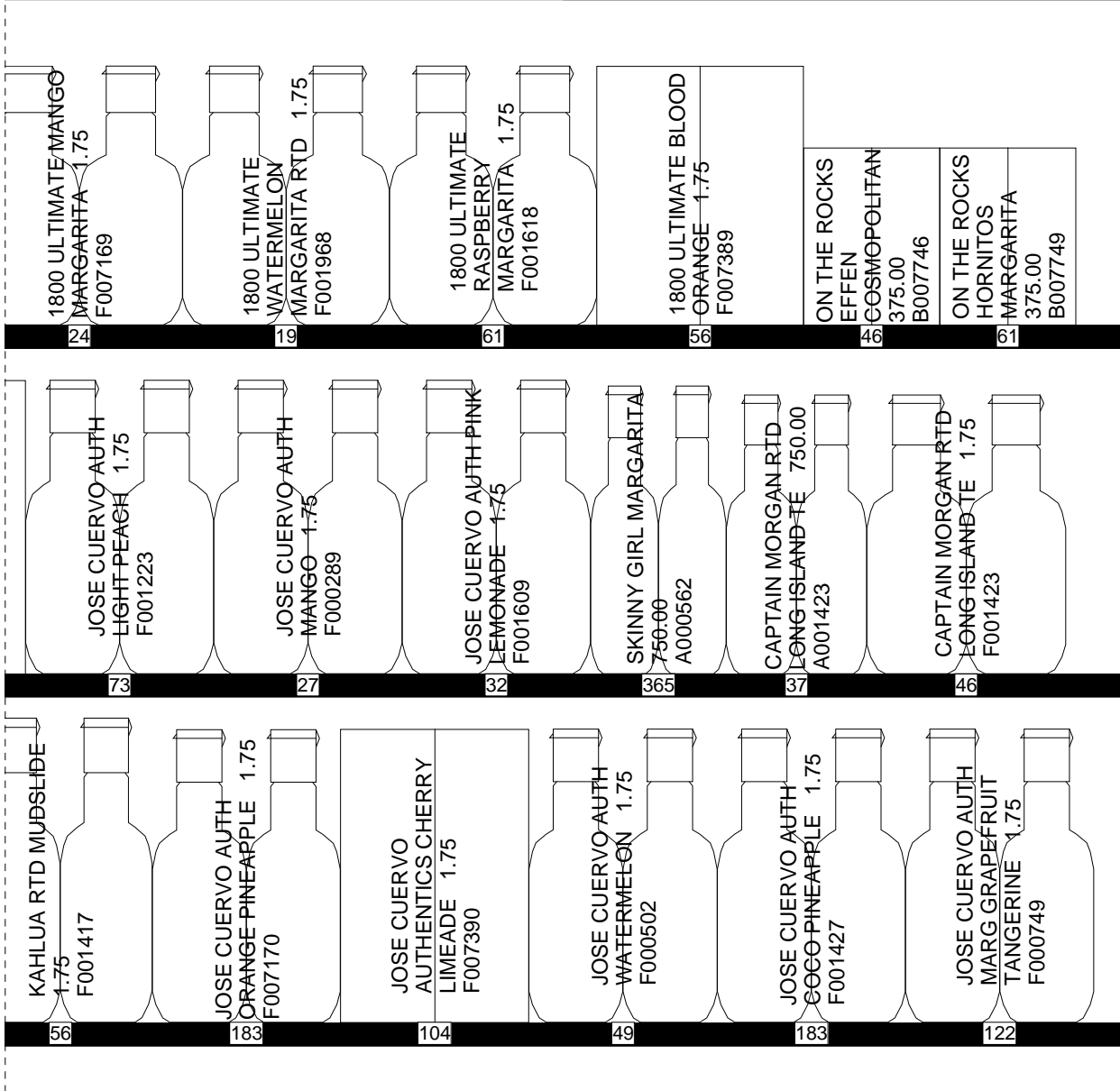

144

156

168

180

192



ABC # 113

16ft x 3 shel f GIN

FRONT



A003013 A003014 A001710 A000903 A005237 A000695 B000641



B000112



B000113 A000113 F000113 F000649 A007585

4 ft

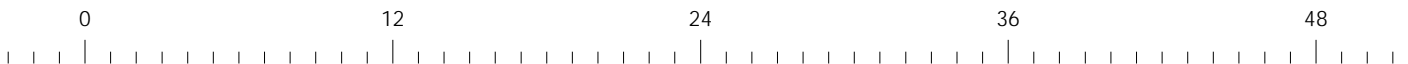



ABC # 113

16ft x 3 shel f GIN

FRONT

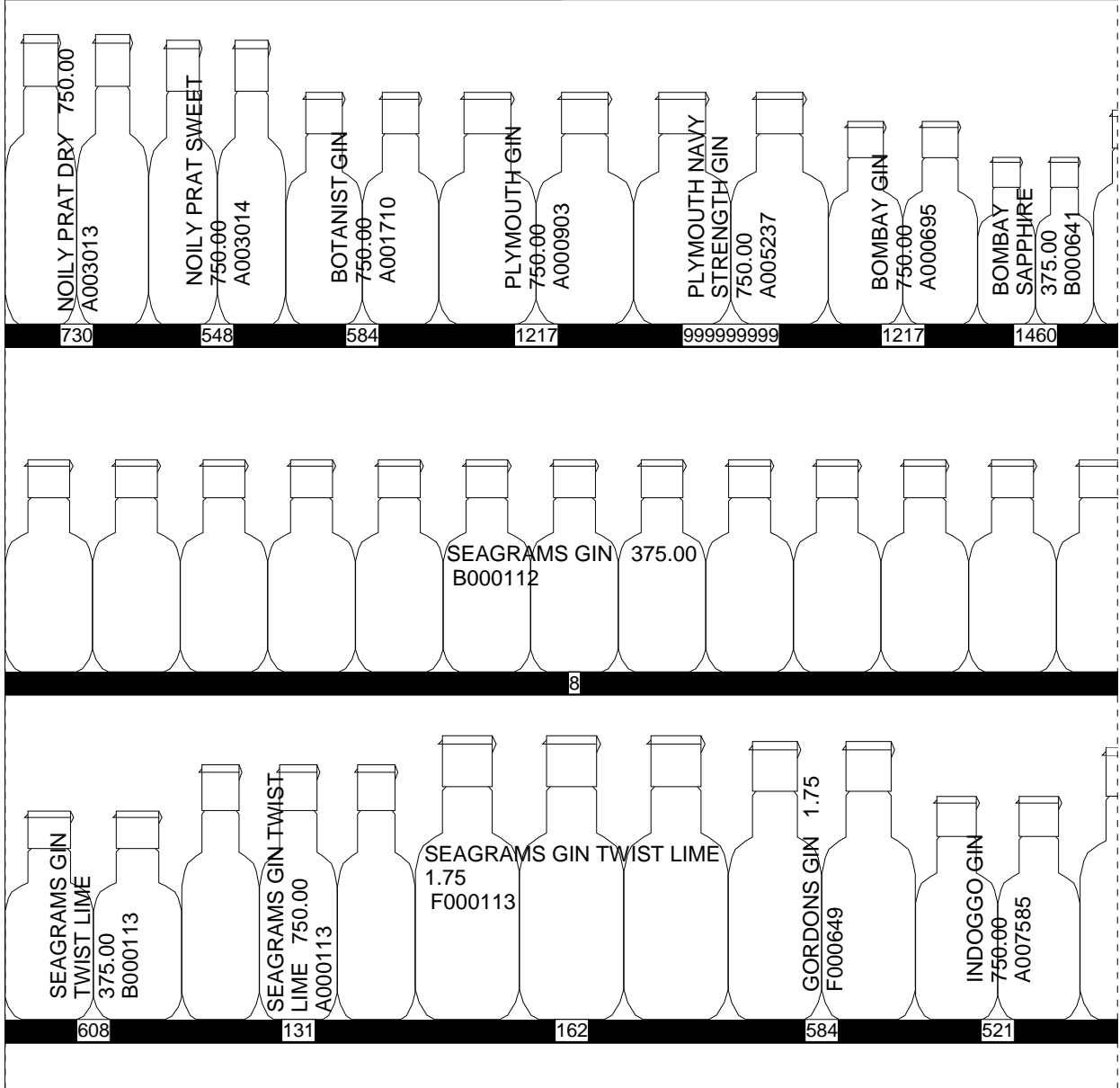

0 12 24 36 48



ABC # 113

16ft x 3 shel f GIN



A000641

E000641

B000689

A000689

E000689



A000112

E000112



F000202

A007027

F000573

B000561

F000561

4 ft

48

60

72

84

96



ABC # 113

16ft x 3 shel f GIN

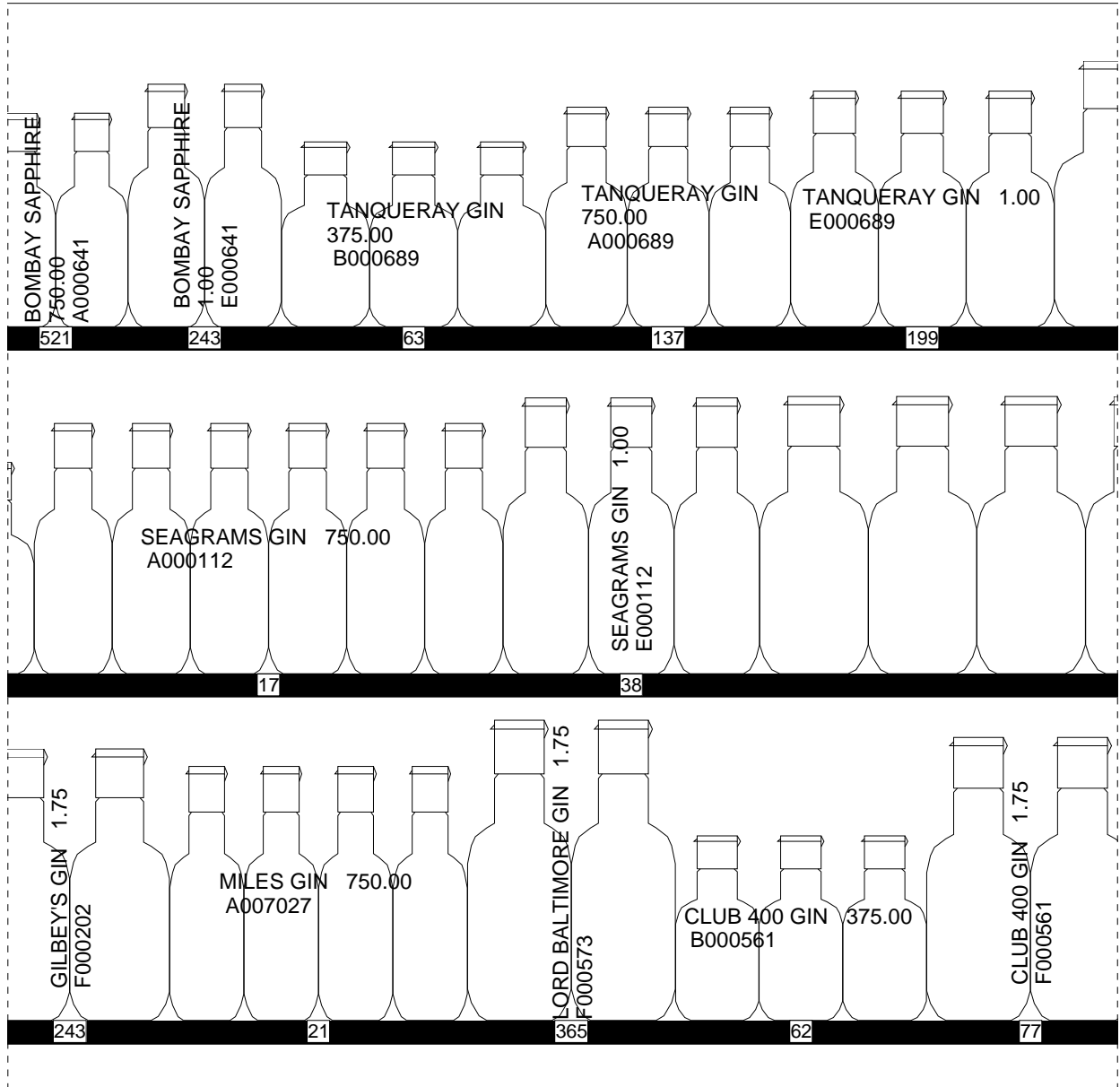

48

60

72

84

96

3/7/2024



ABC # 113

16ft x 3 shel f GIN



F000689 A000687 A007050 A000913 A000545 F000545 B00008



F000112



B000039

4 ft

96 108 120 132 144



ABC # 113

16ft x 3 shel f GIN

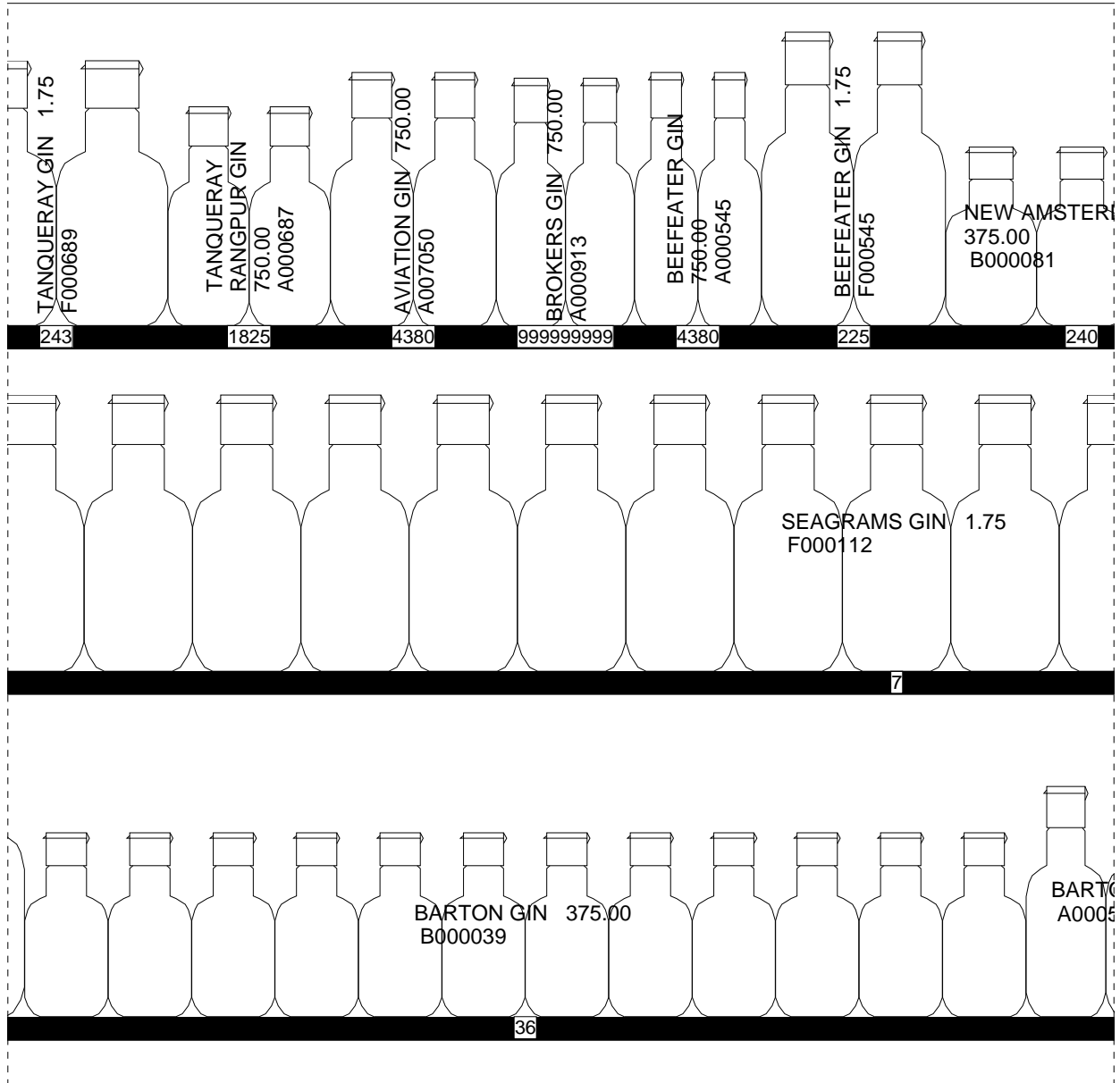

96

108

120

132

144

3/7/2024



ABC # 113

16ft x 3 shel f GIN



144

156

168

180

192



ABC # 113

16ft x 3 shel f GIN

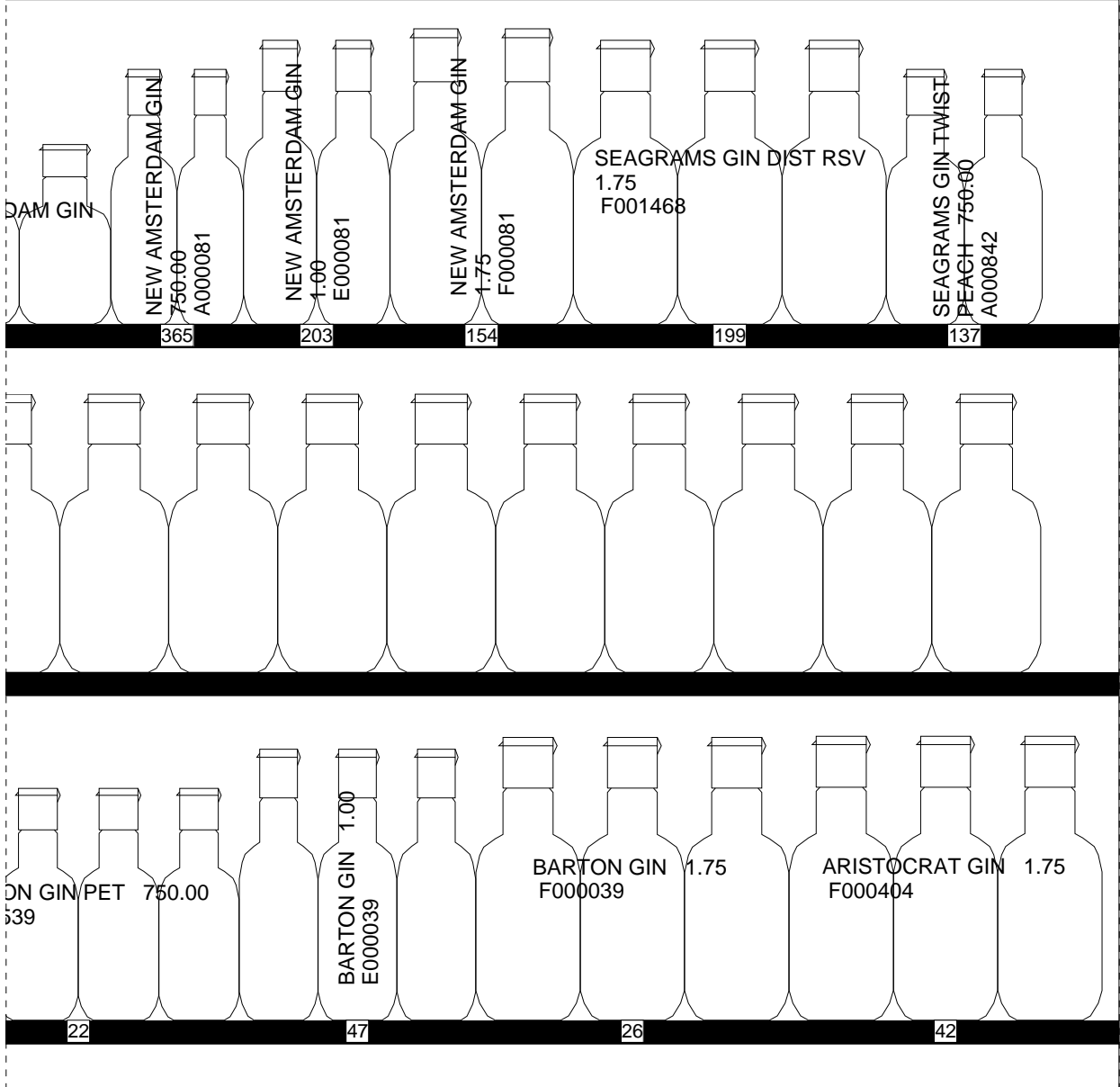

144

156

168

180

192

3/7/2024



ABC # 113

16ft x 3 shel f CORDIALS / SPECIALTIES & MIXERS

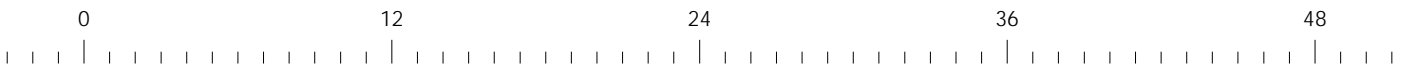
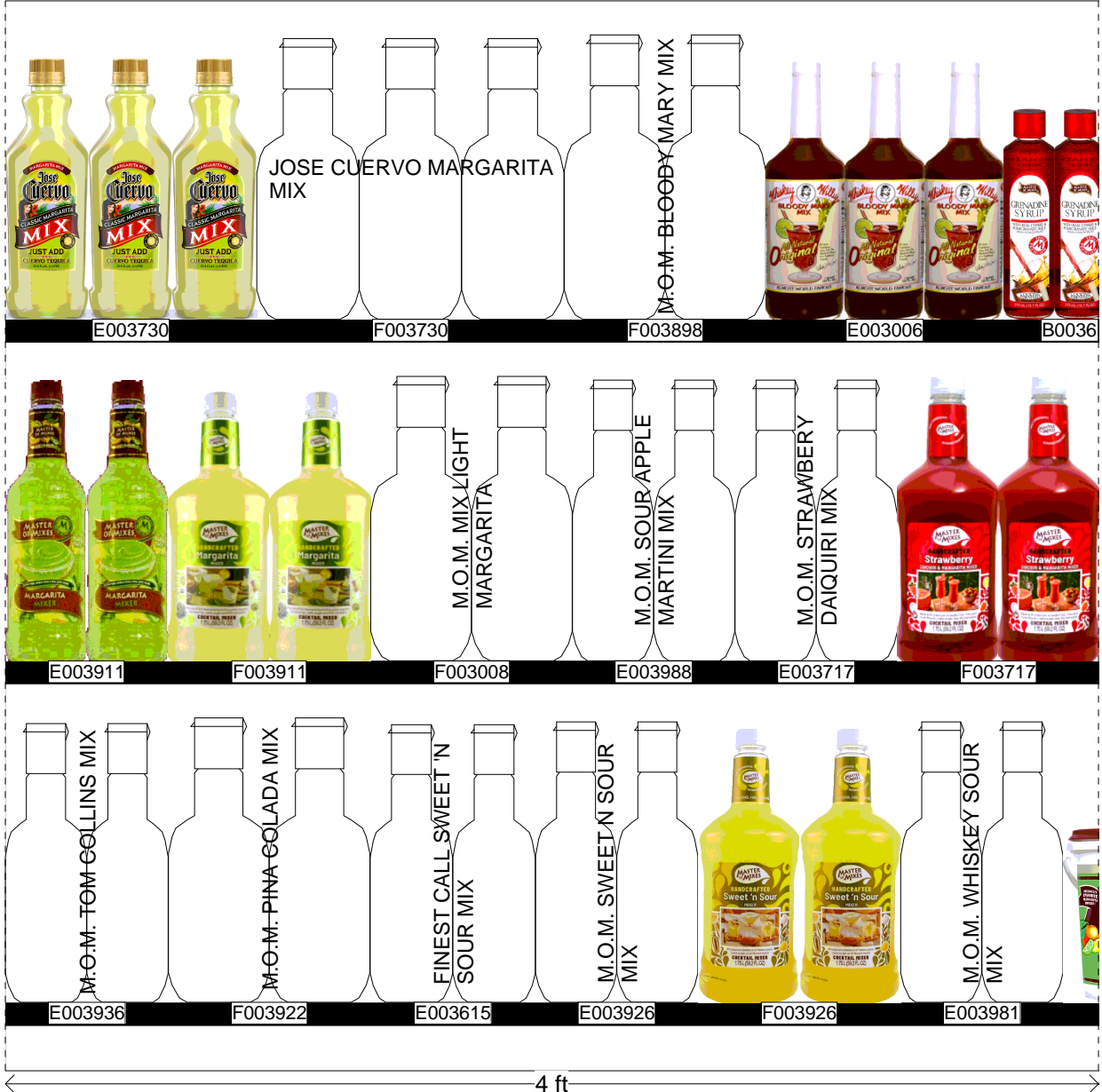



ABC # 113

16ft x 3 shel f CORDIALS /
SPECIALTIES & MIXERS

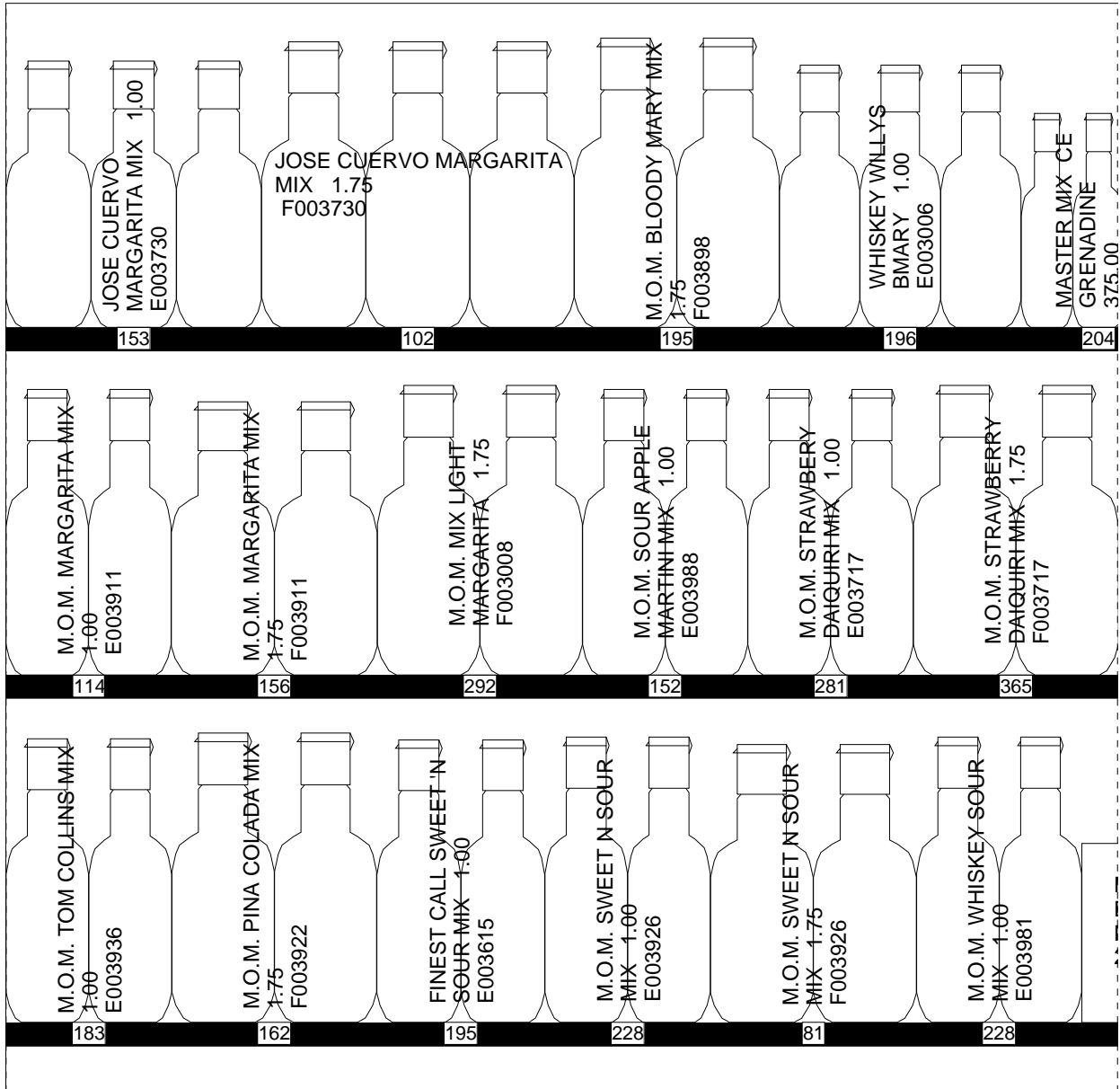

0

12

24

36

48

3/7/2024



ABC # 113

16ft x 3 shel f CORDIALS /
SPECIALTIES & MIXERS



18 B003719 B000425 A000425 E000425 F000425 A000217

E003618 A001818 A007014 A001534 A070159 A007677 A007782

H003619 E000663 F000663 E000424 A000165 A000260

48 60 72 84 96



ABC # 113

16ft x 3 shel f CORDIALS /
SPECIALTIES & MIXERS

B003618	MASTER MIX CE LIME JUICE 375.00 B003749	KAHLUA 375.00 B000425	KAHLUA 750.00 A000425	KAHLUA 1.00 E000425	KAHLUA 1.75 F000425	RUM CHATA 750.00 A000217
515	243	215	730	584	197	
FINEST CALL GRENADINE 1.00 E003618	BLUE CHAIR KEY LIME CREAM 750.00 A001818	BLUE CHAIR BAY PINEAPPLE RUM CREAM 750.00 A007014	BLUE CHAIR BANANA CREAM 750.00 A001534	MURDER CREEK COCONUT CREAM MOONSHINE 750.00 A070159	SUGARLANDS DARK CHOCOLATE COFFEE CREAM 750.00 A007677	OLE SMOKEY BANANA PUDDING CREAM 750.00 A007782
243	456	3650	135	999999999	608	69
MOM BIG BUCKET OF MARGARITA 2.00 H003619	KAMORA COFFEE 1.00 E000663	KAMORA COFFEE 1.75 F000663	COPA DE ORO 1.00 E000424	EMMETS IRISH CREAM 750.00 A000165	ST BRENDANS IRI CREAM 750.00 A000260	
146	195	999999999	2920	584	365	

48

60

72

84

96

3/7/2024



ABC # 113

16ft x 3 shel f CORDIALS /
SPECIALTIES & MIXERS



96

108

120

132

144



ABC # 113

16ft x 3 shel f CORDIALS /
SPECIALTIES & MIXERS

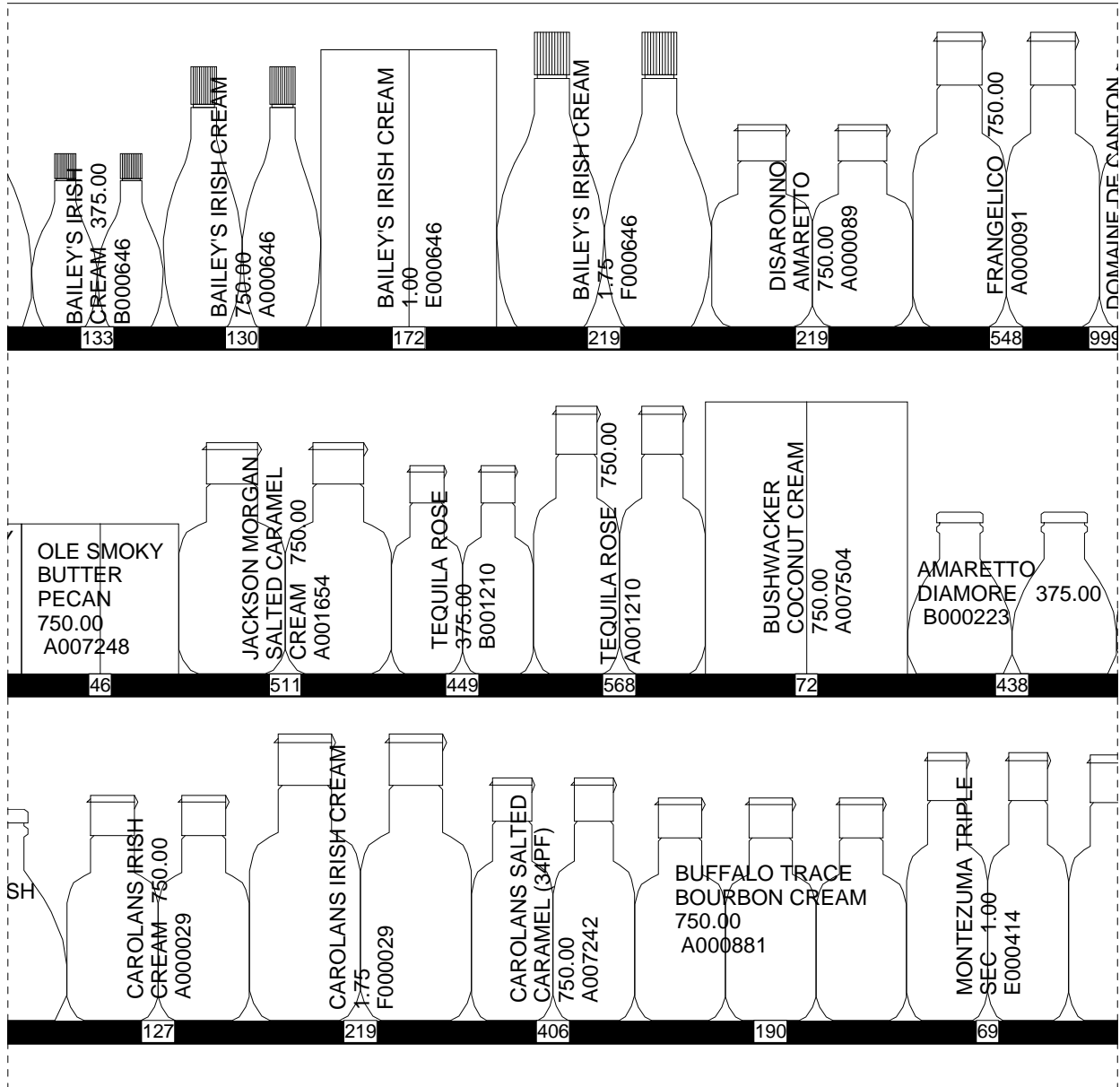

96

108

120

132

144

3/7/2024



ABC # 113

16ft x 3 shel f CORDIALS /
SPECIALTIES & MIXERS

FRONT



000513 A000817 A000167 B000692 A000692 E000692 B000013

A000223 E000223 F000223 A000001 A001172

E000257 F000257 E000823 A000038 E008041 A000027

4 ft

144 156 168 180 192



ABC # 113

16ft x 3 shel f CORDIALS / SPECIALTIES & MIXERS

FRONT

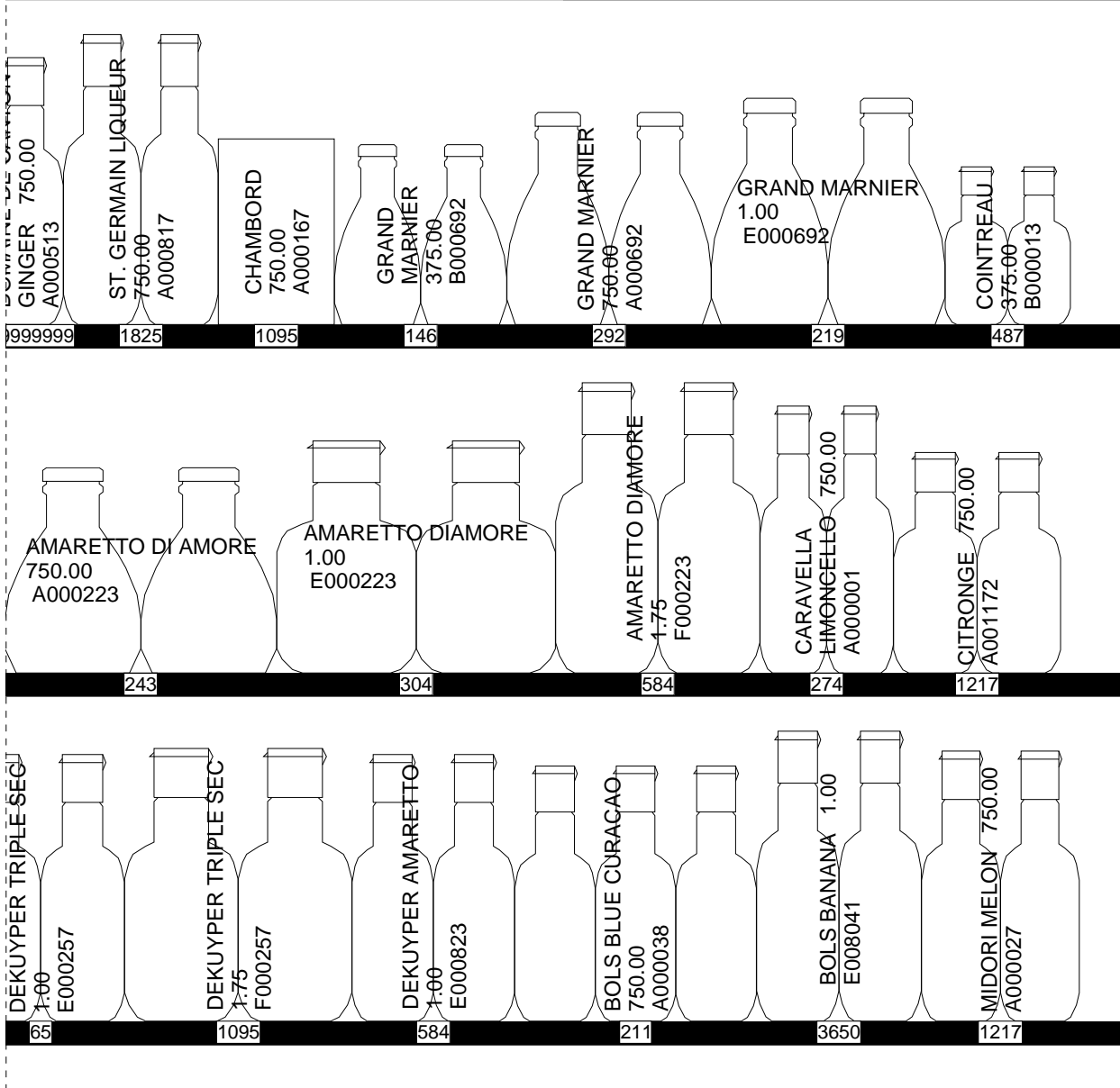

144

156

168

180

192

3/7/2024



ABC # 113

16ft x 3 shel f SHOOTERS / FUSIONS / MOONSHINE

FRONT



B007210 A007210 B000396 A000396 E000396 F000396



A007449 A000909 A001914 A000921 A001322 A000550 B000605 A



A000097 B000067 A000067 E000067 F000067 B000086

4 ft

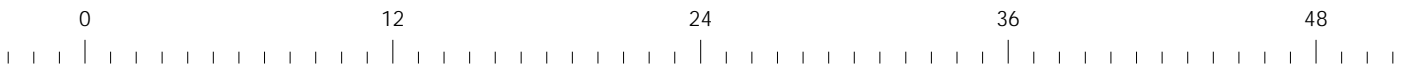



ABC # 113

16ft x 3 shel f SHOOTERS / FUSIONS / MOONSHINE

FRONT

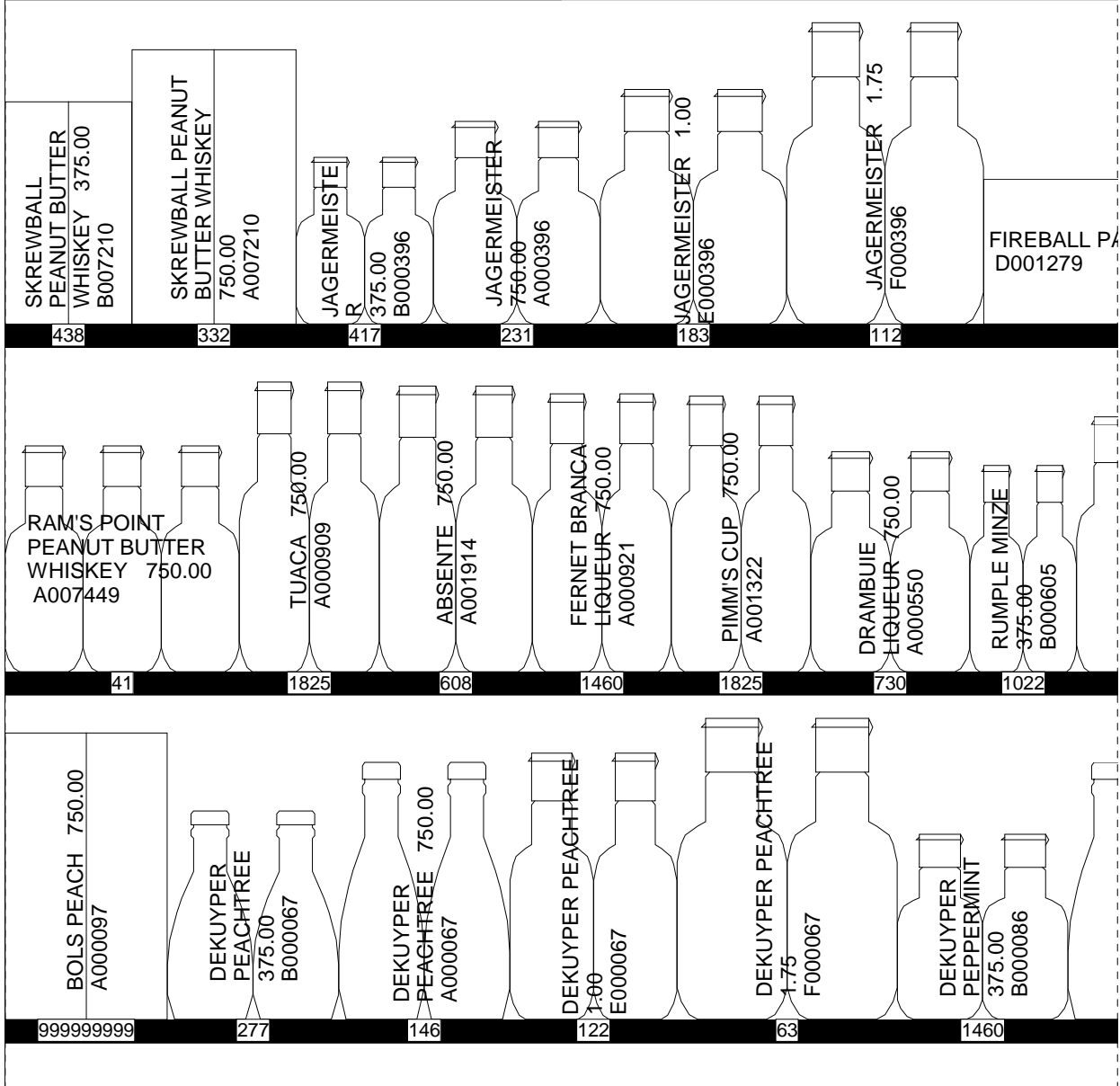

0 12 24 36 48



ABC # 113

16ft x 3 shel f SHOOTERS / FUSIONS / MOONSHINE



D001279

B000327

A000327

A001102

E000327

F

000605

A000628

A007961

A001197

D001933

A000086

A000254

A001229

E008156

E000072

A008161

E0

4 ft

48

60

72

84

96



ABC # 113

16ft x 3 shel f SHOOTERS / FUSIONS / MOONSHINE

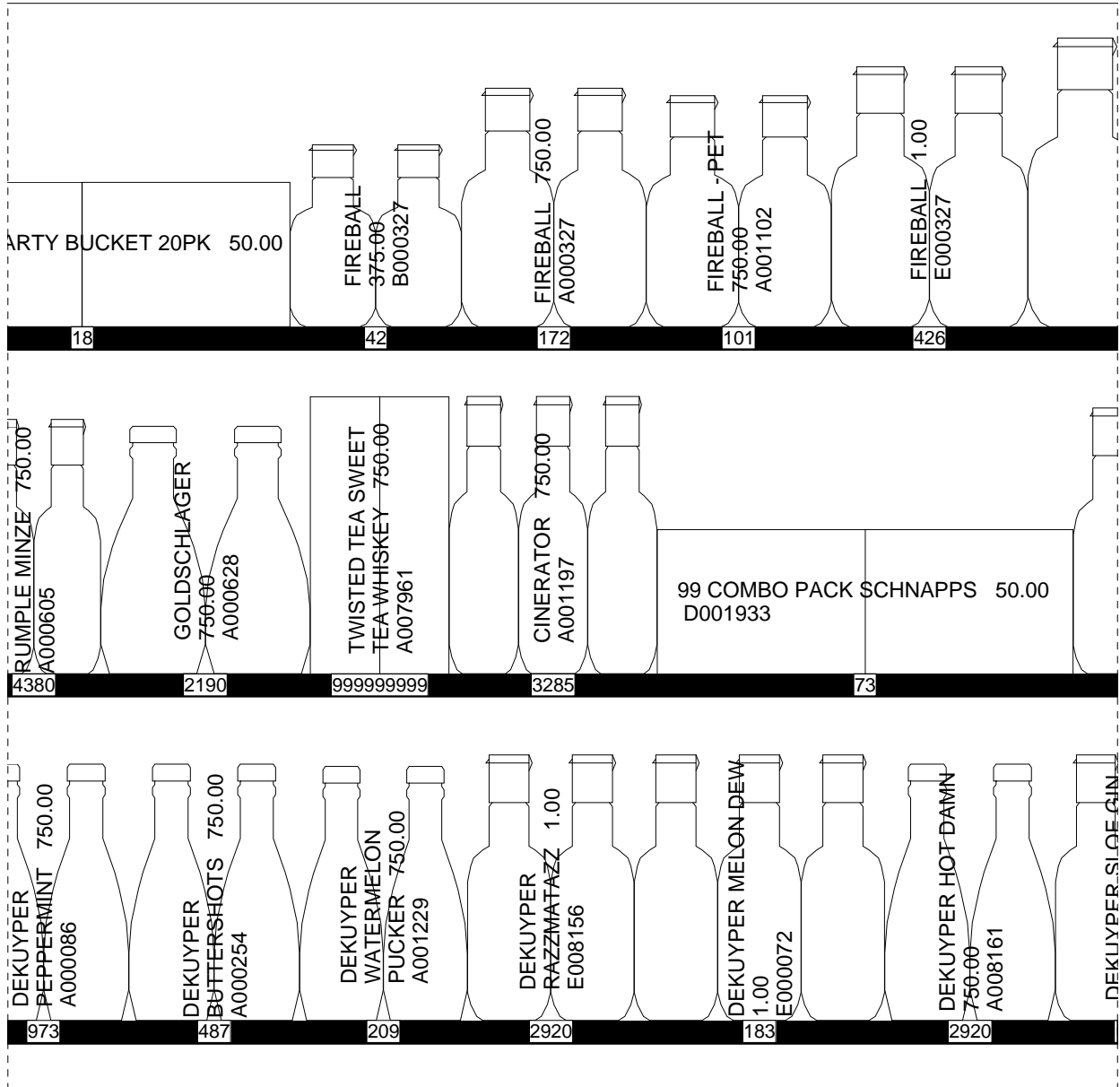

48

60

72

84

96

3/7/2024



ABC # 113

16ft x 3 shel f SHOOTERS / FUSIONS / MOONSHINE



00327 B001637 A001637 F001637 A000923 A000521 A00



A000399 A000430 A000826 A001001 A000618 A00



01381 E002853 A001042 A007734 A000073 A00

4 ft

96 108 120 132 144



ABC # 113

16ft x 3 shel f SHOOTERS / FUSIONS / MOONSHINE

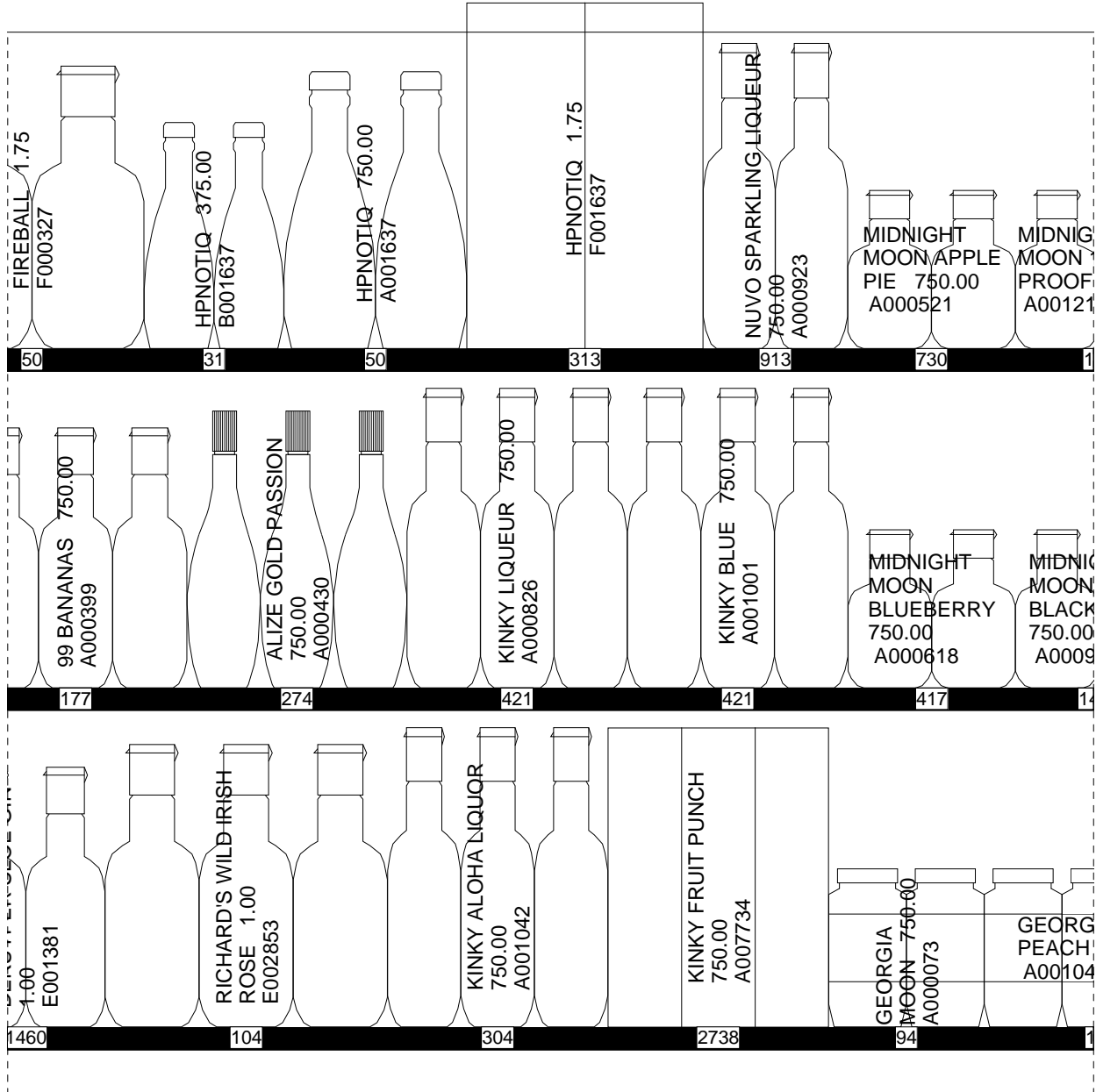

96

108

120

132

144

3/7/2024



ABC # 113

16ft x 3 shel f SHOOTERS / FUSIONS / MOONSHINE



1215 A000258 A001385 A001601 A001780 A007178 A001438 A001440



0958 A000520 A001641 A001055 A007658 A007221 A007393 A007529



1045 A000942 A009767 MURDER CREEK DIXIE DIZZY PICKLE MOONSHNE A001386 A001388 A007841

← 4 ft →

144 156 168 180 192



ABC # 113

16ft x 3 shel f SHOOTERS / FUSIONS / MOONSHINE

HT 100 750.00 5	MIDNIGHT MOON MOONSHINE 750.00 A000258	OLE SMOKY MOONSHINE 750.00 A001385	OLE SMOKY CHERRIES 750.00 A001601	OLE SMOKEY HUNCH PUNCH 750.00 A001780	SUGARLANDS SHINE APPLE PIE MOONSHINE 750.00 A007178	SUGARLANDS SHINE BUTTERSCOTCH 750.00 A001438	TIM SMITH'S CLIMAX MOONSHINE 750.00 A001440
33	94	548	548	122	456	730	487
GHT BERRY 58	MIDNIGHT MOON STRAWBERRY 750.00 A000520	OLE SMOKEY PEACHES 750.00 A001641	OLE SMOKY BLUE FLAME MOONSHINE 750.00 A001055	OLE SMOKY SOUR WATERMELON 750.00 A007658	OLE SMOKY MOONSHINE PICKLES 750.00 A007221	SUGARLAND'S PINA COLADA 750.00 A007393	SUGARLAND BUTTER PECAN 750.00 A007529
160	1460	174	126	1825	608	1217	203
IA MOON 750.00 5	FIREFLY MOONSHINE APPLE PIE 750.00 A000942	MURDER CREEK DIXIE DIZZY PICKLE MOONSHINE 750.00 A009767	AMERICAN BORN MOONSHINE ORIGINAL 750.00 A001386	AMERICAN BORN APPLE PIE MOONSHINE 750.00 A001388	PINEAPPLE UPSIDE DOWN CAKE LIQUEUR 750.00 A007841		
30	1460	406	274	584	913		

144

156

168

180

192

3/7/2024



ABC # 113

20ft x 3 shel f BRANDY / COGNAC





ABC # 113

20ft x 3 shel f BRANDY / COGNAC

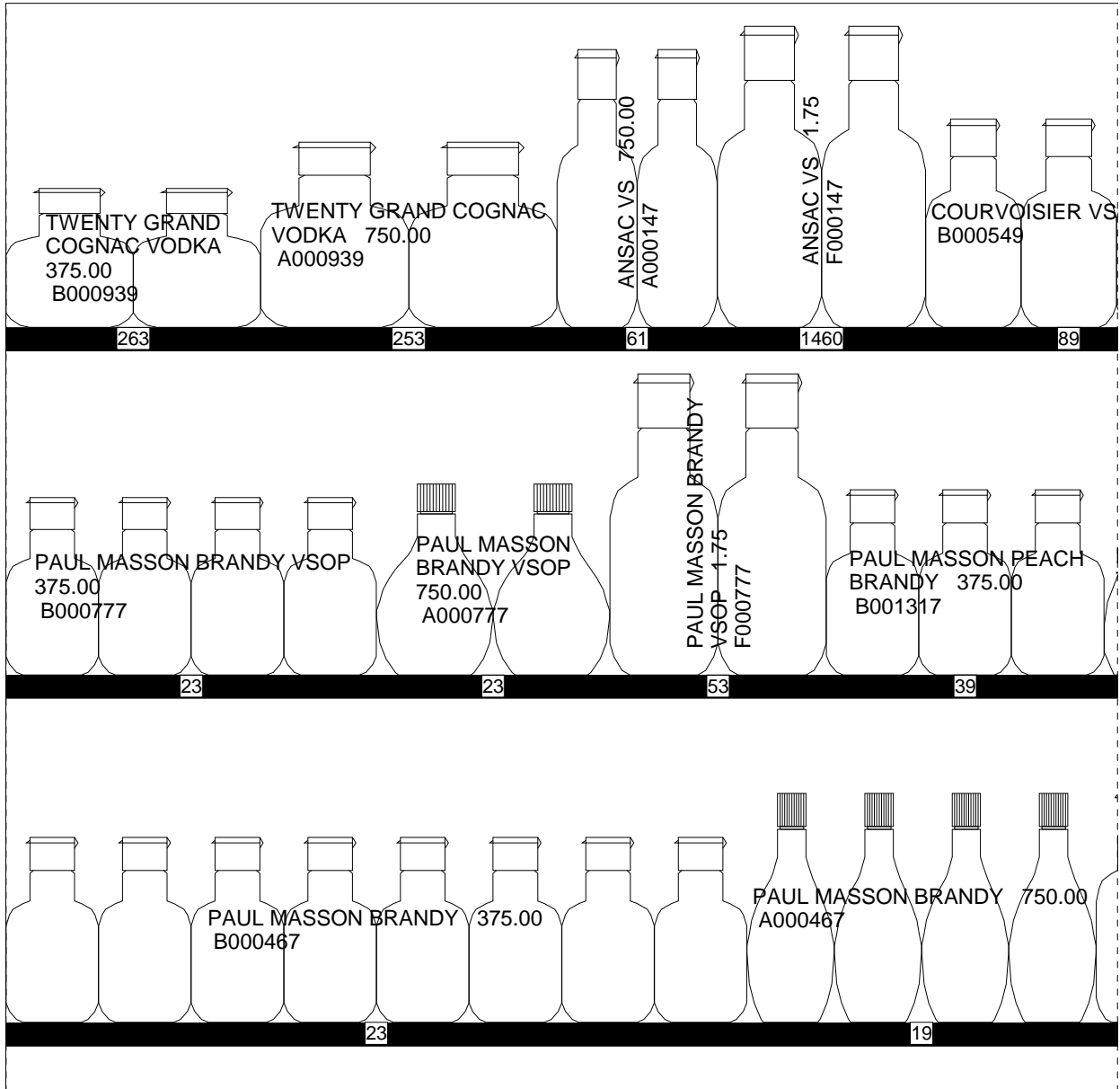

0

12

24

36

48

3/7/2024



ABC # 113

20ft x 3 shel f BRANDY / COGNAC



A000549

A000022

B000322



A001317

F001317

A007964

A001740



A001466

E000467

F000467

B001741

4 ft

48

60

72

84

96



ABC # 113

20ft x 3 shel f BRANDY / COGNAC

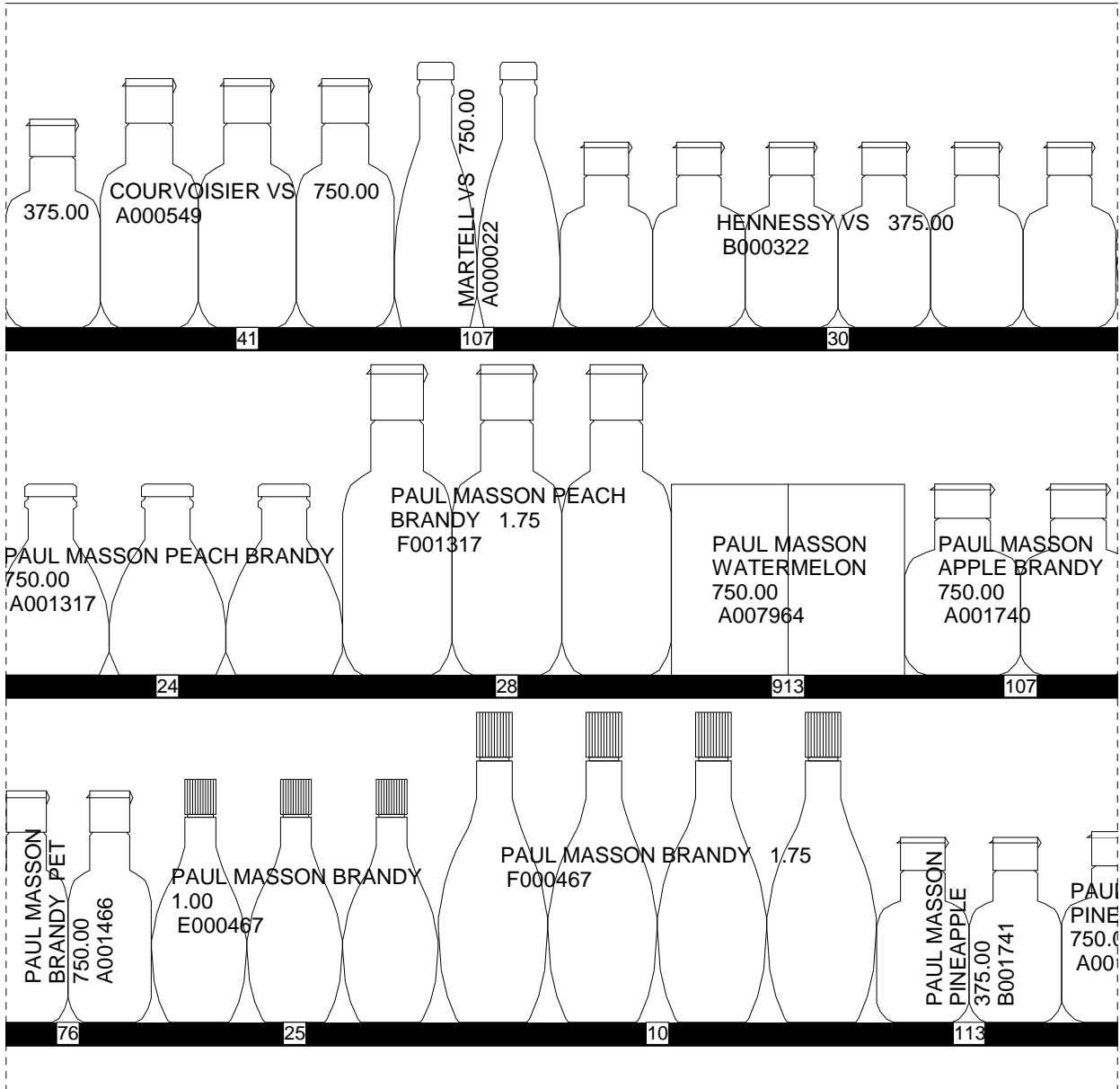

48

60

72

84

96

3/7/2024



ABC # 113

20ft x 3 shel f BRANDY / COGNAC



A000322

F000322



B001836

A001836

B001690

A001690



A001741

A001520

B000690

A001692

A000690

E0

4 ft

96

108

120

132

144



ABC # 113

20ft x 3 shel f BRANDY / COGNAC

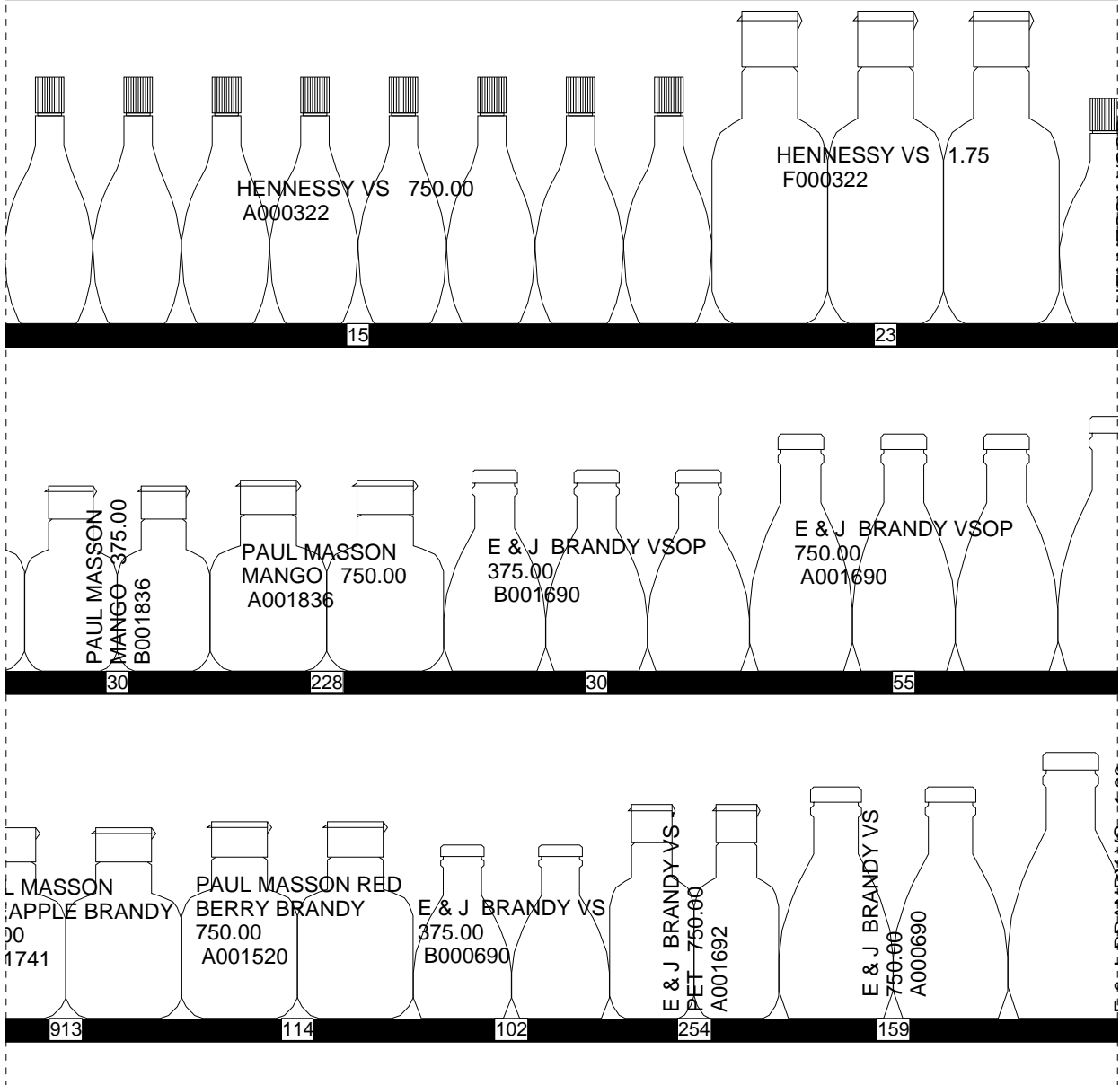

96

108

120

132

144

3/7/2024



ABC # 113

20ft x 3 shel f BRANDY / COGNAC



000622 A001776 A000774 B000669 A000669 B000792

E001690 F001690 B001689 A001689 F001689

00690 F000690 A001816 A001775 B000422

4 ft

144

156

168

180

192



ABC # 113

20ft x 3 shel f BRANDY / COGNAC

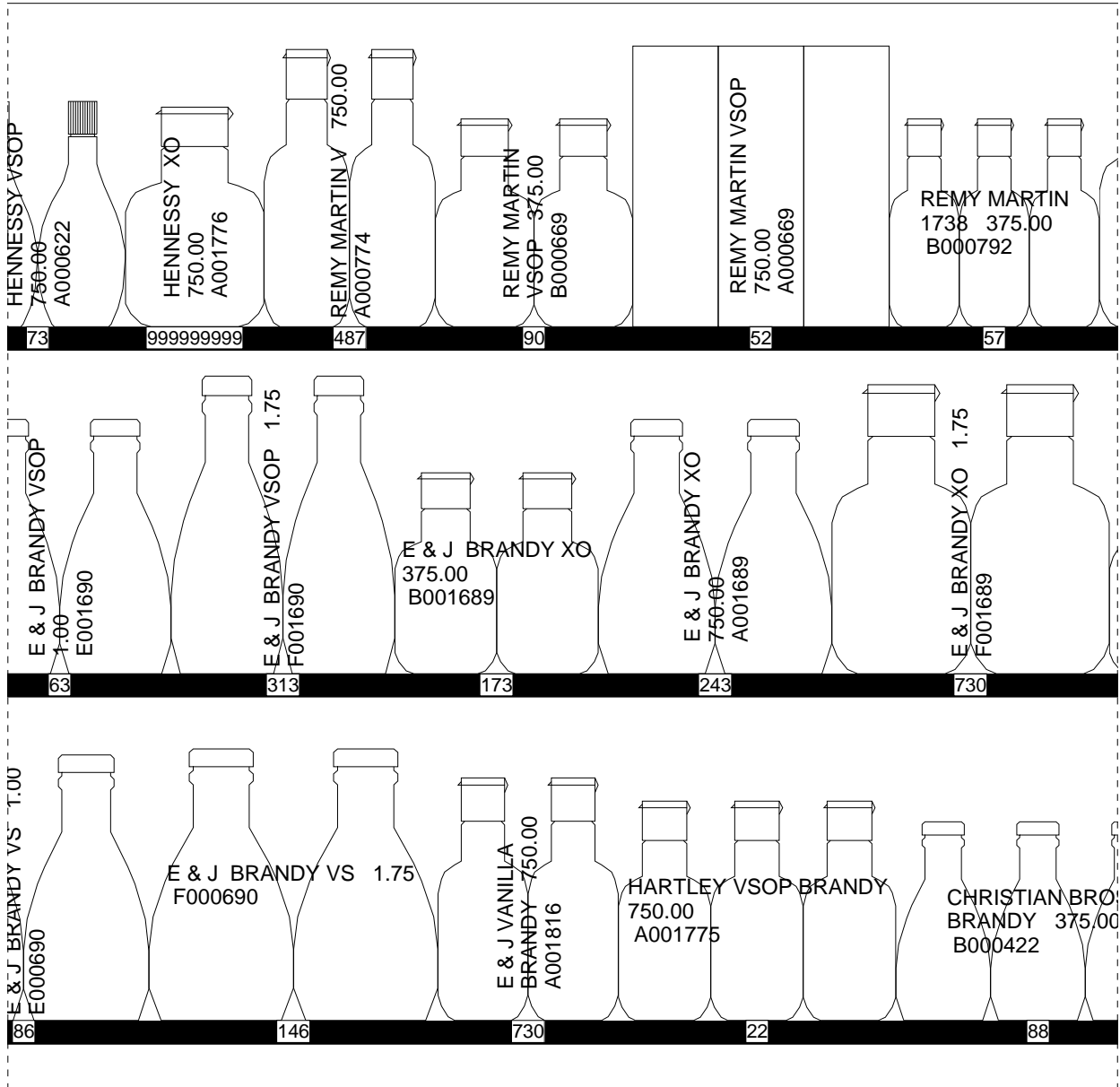

144

156

168

180

192

3/7/2024



ABC # 113

20ft x 3 shel f BRANDY / COGNAC

FRONT



4 ft

192

204

216

228

240



ABC # 113

20ft x 3 shel f BRANDY / COGNAC

FRONT

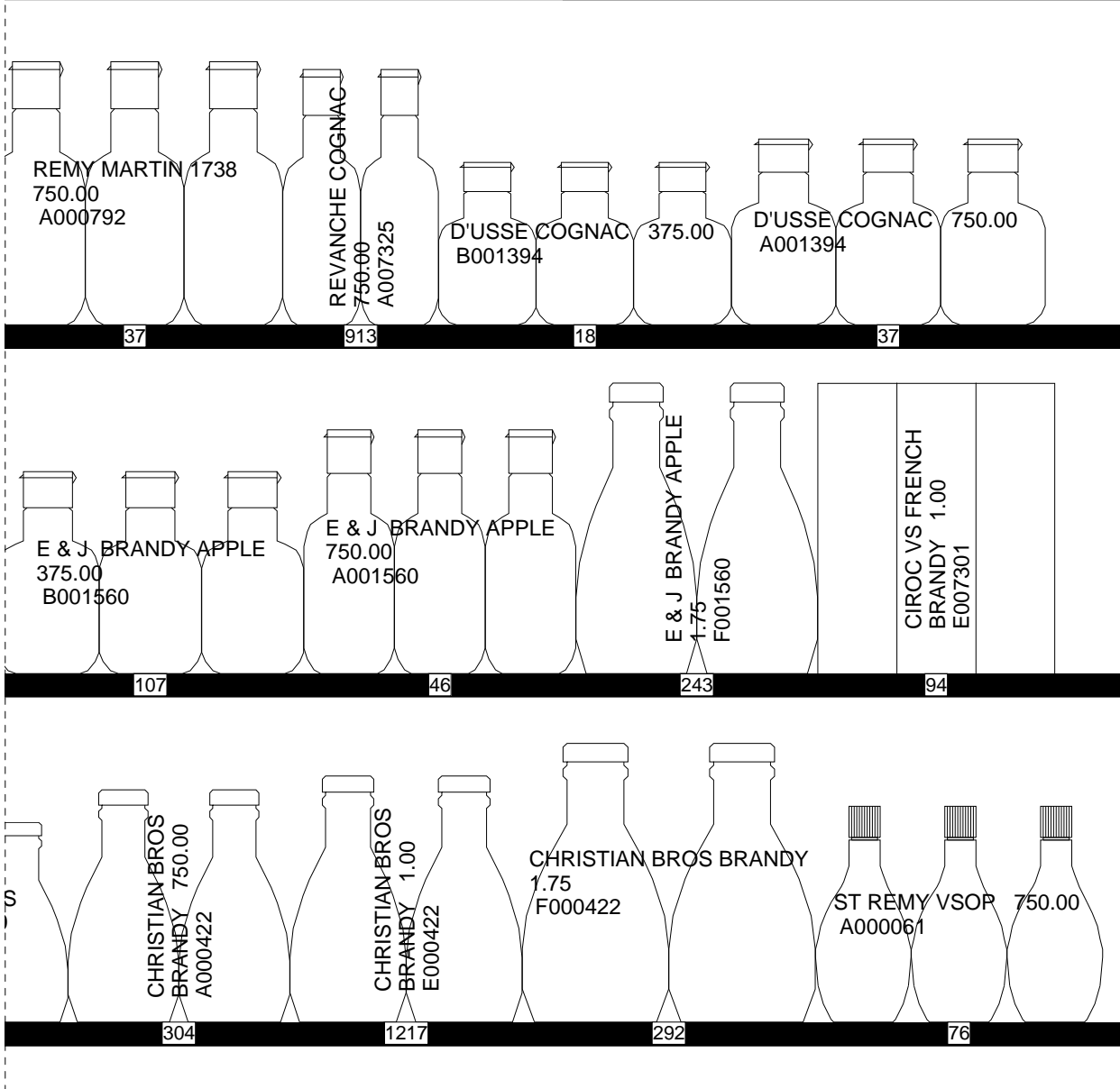

192

204

216

228

240

3/7/2024



ABC # 113

20ft x 3 shel f SCOTCH & CLOSEOUT & VAP

FRONT



A001688 B000110 A000110 E000110 F000110 A000096



A001373 A007048 B000688 A000688 E000688 F000688 A000686



A000670 F000670 A000475 F000475

4 ft

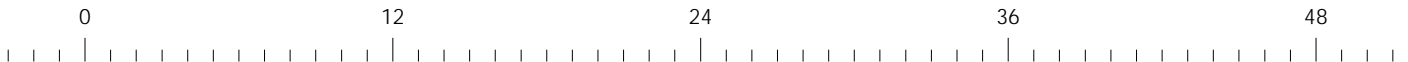



ABC # 113

20ft x 3 shel f SCOTCH & CLOSEOUT & VAP

FRONT

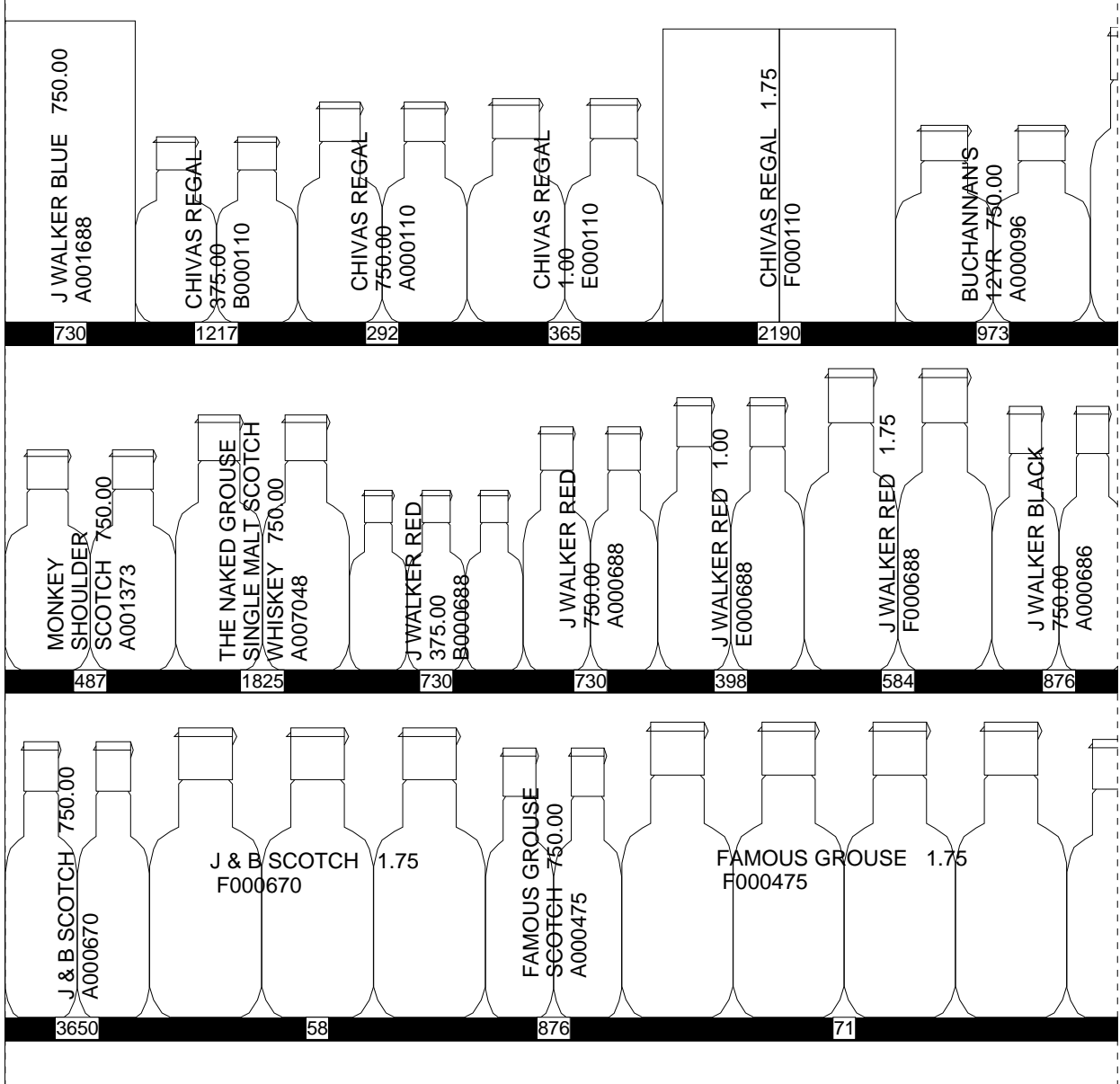

0

12

24

36

48



ABC # 113

20ft x 3 shel f SCOTCH & CLOSEOUT & VAP



A000420 A001757 B000106 A000106 F000106 A001739 A0000



E000686 F000686 B000095 A000095 E000095 F000095



F000014 F000171 F000094 F000015

4 ft

48 60 72 84 96



ABC # 113

20ft x 3 shel f SCOTCH & CLOSEOUT & VAP

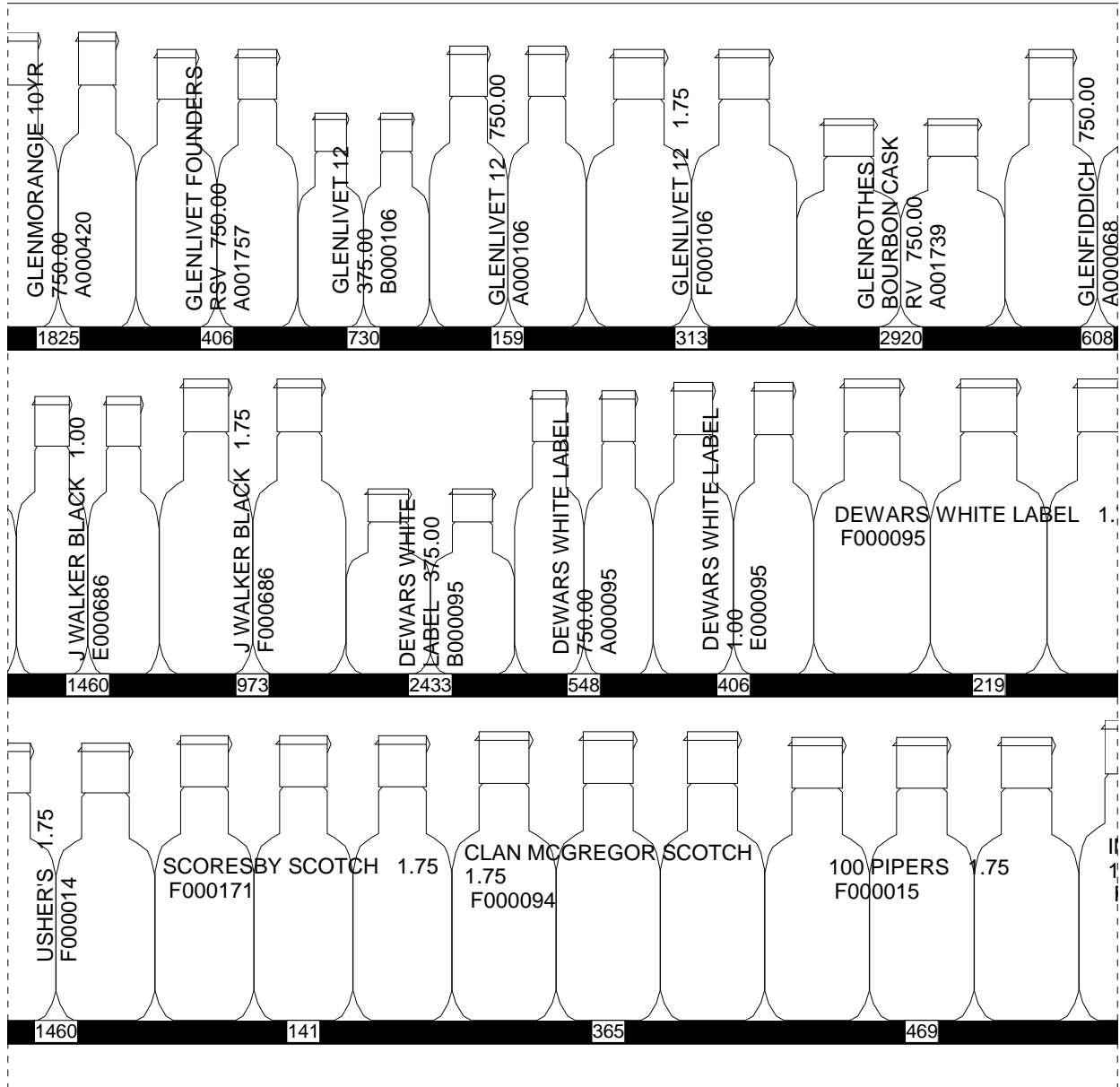

48

60

72

84

96

3/7/2024



ABC # 113

20ft x 3 shel f SCOTCH & CLOSEOUT & VAP



68 A00097 A000324 A001922



A001095 F001095



F000255 F000041

4 ft

96 108 120 132 144



ABC # 113

20ft x 3 shel f SCOTCH & CLOSEOUT & VAP

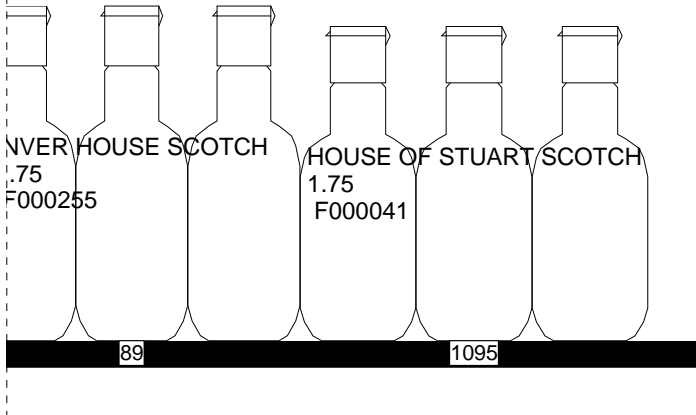
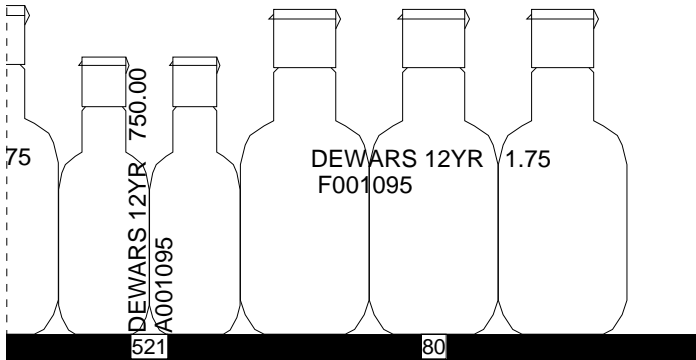
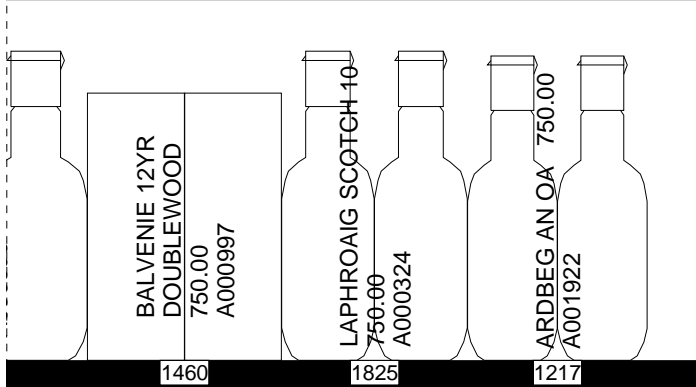

96

108

120

132

144

3/7/2024



ABC # 113

20ft x 3 shel f SCOTCH &
CLOSEOUT & VAP

CLOSEOUT & VAP



144

156

168

180

192



ABC # 113

20ft x 3 shel f SCOTCH &
CLOSEOUT & VAP

CLOSEOUT & VAP



144

156

168

180

192



ABC # 113

20ft x 3 shel f SCOTCH &
CLOSEOUT & VAP

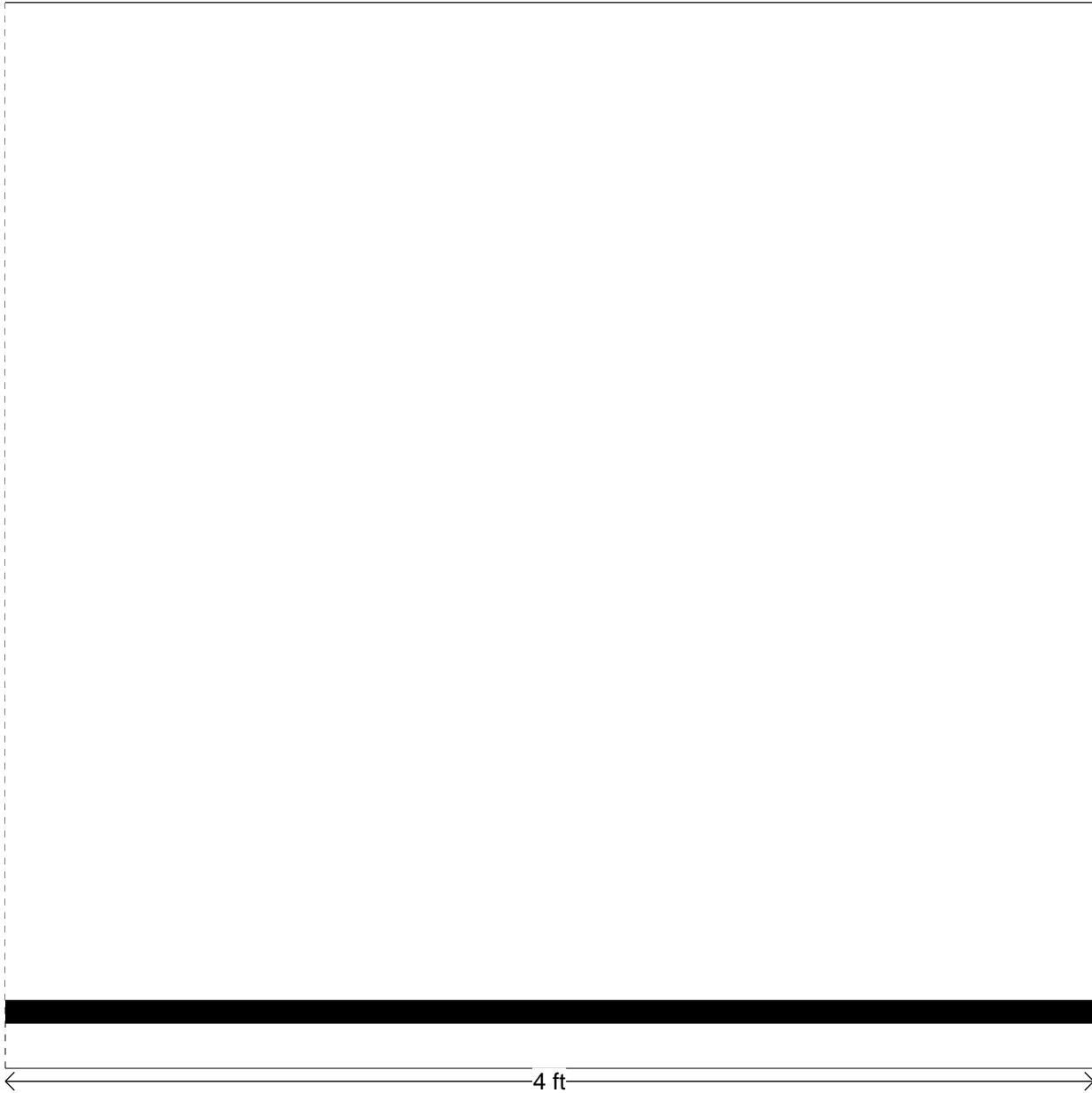

192

204

216

228

240



ABC # 113

20ft x 3 shel f SCOTCH &
CLOSEOUT & VAP



192

204

216

228

240



3/7/2024



ABC # 113

12ft x 6 shel f SMALL SIZE

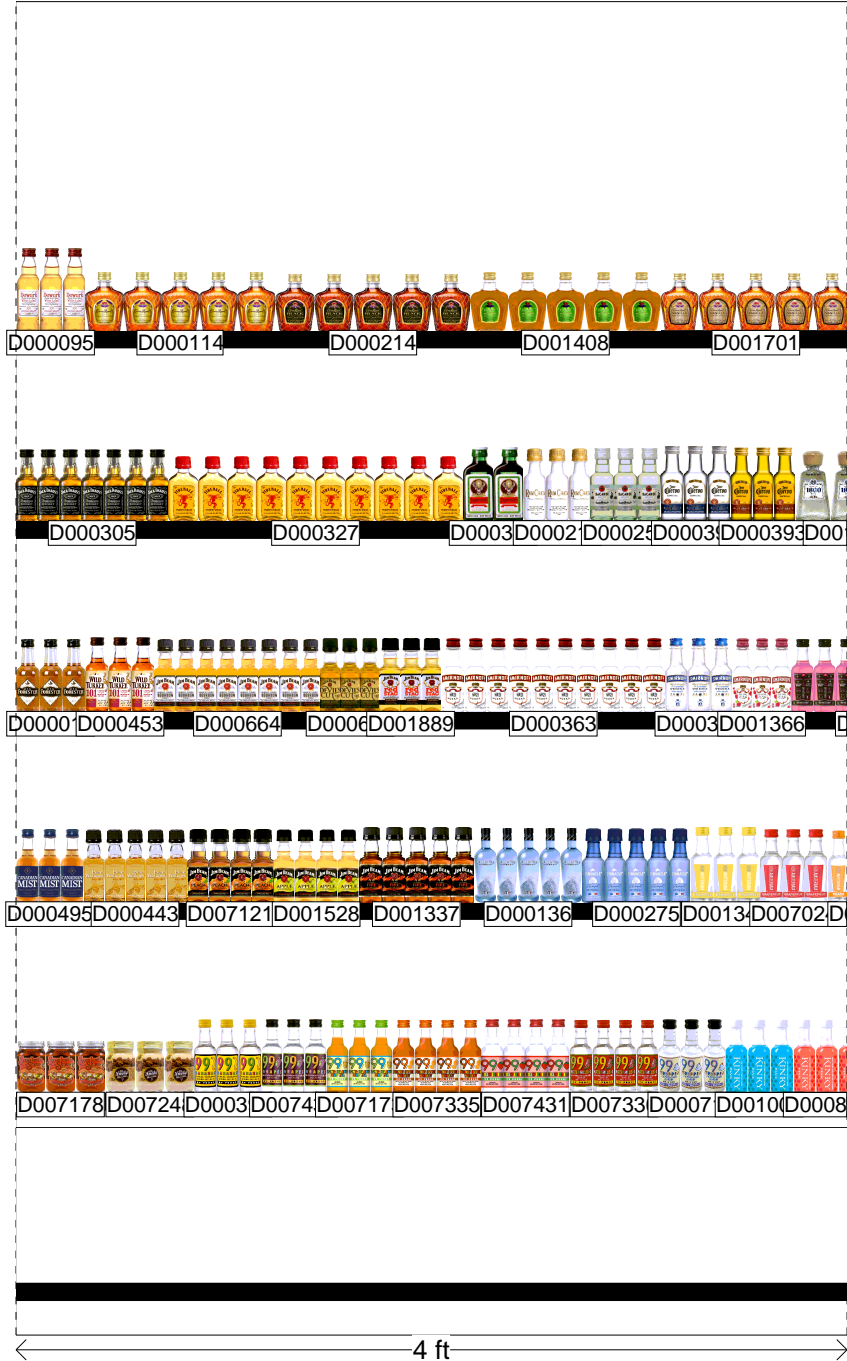



ABC # 113

12ft x 6 shel f SMALL SIZE

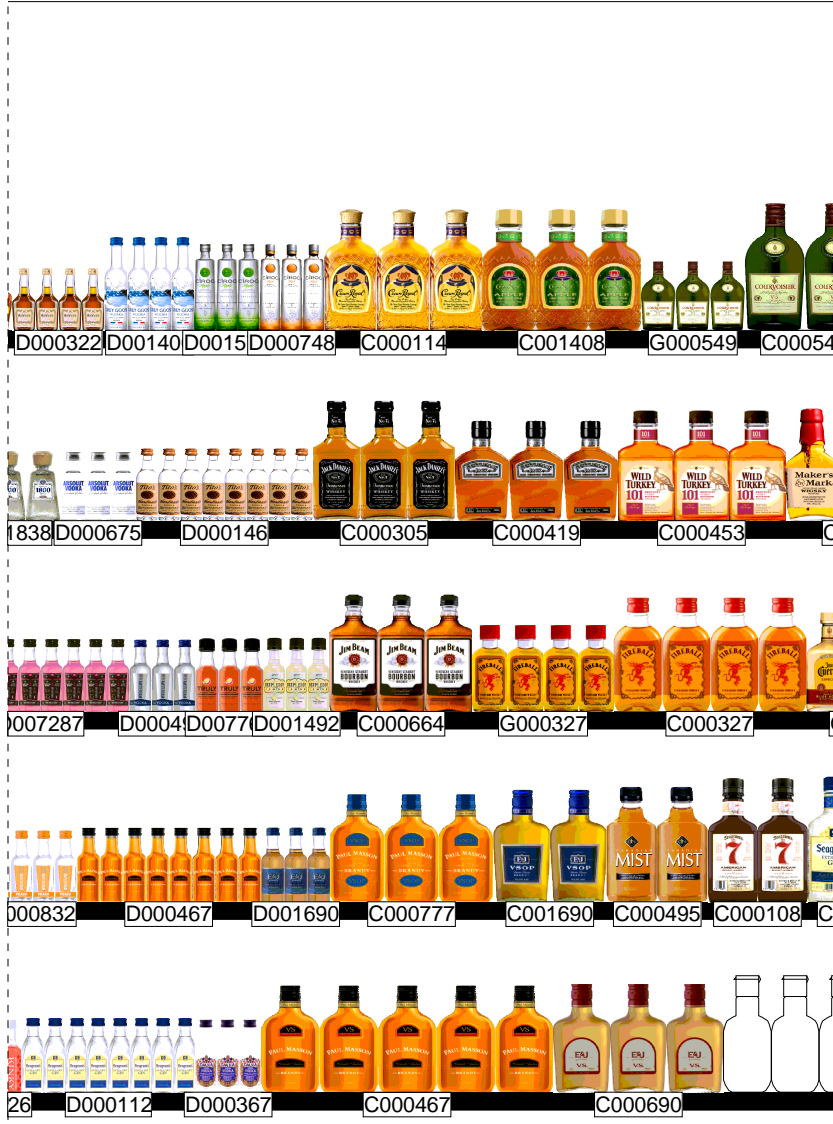

Backstock

4 ft





ABC # 113

12ft x 6 shel f SMALL SIZE

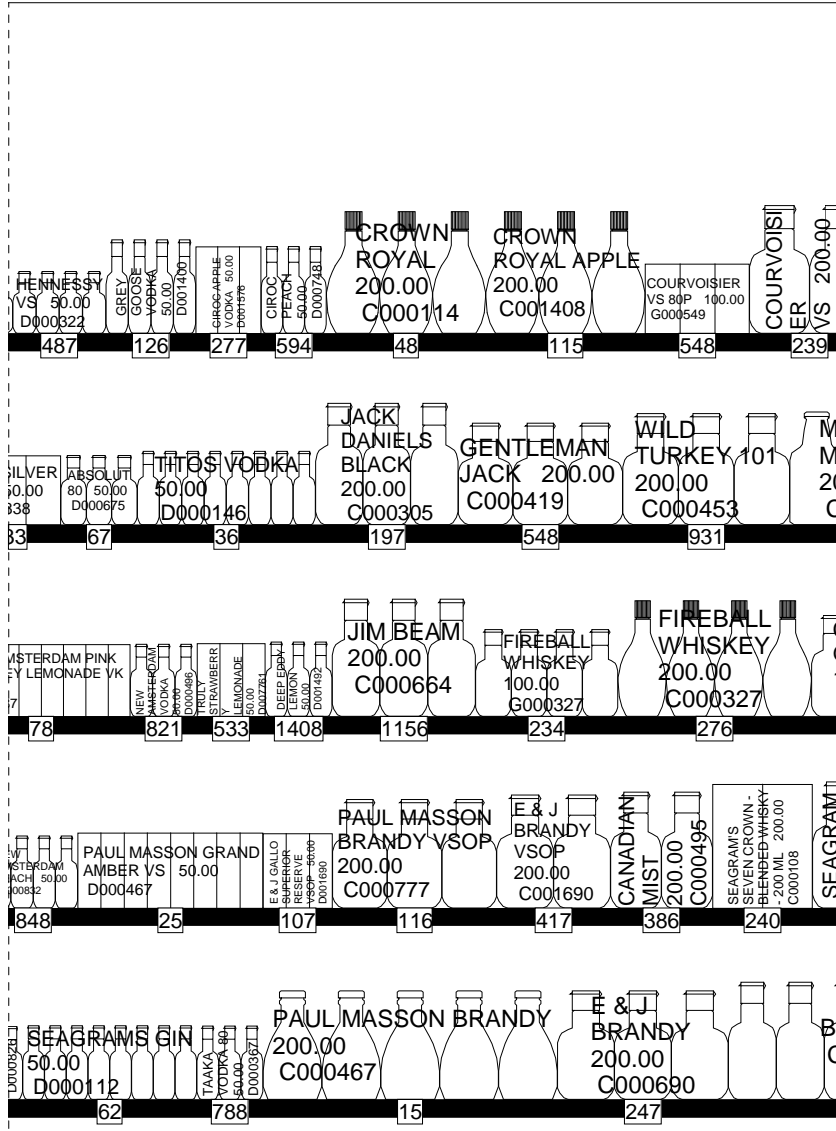

Backstock



36

48

60

72

84

96

108

3/7/2024



ABC # 113

12ft x 6 shel f SMALL SIZE



84

96

108

120

132

144

156



ABC # 113

12ft x 6 shel f SMALL SIZE

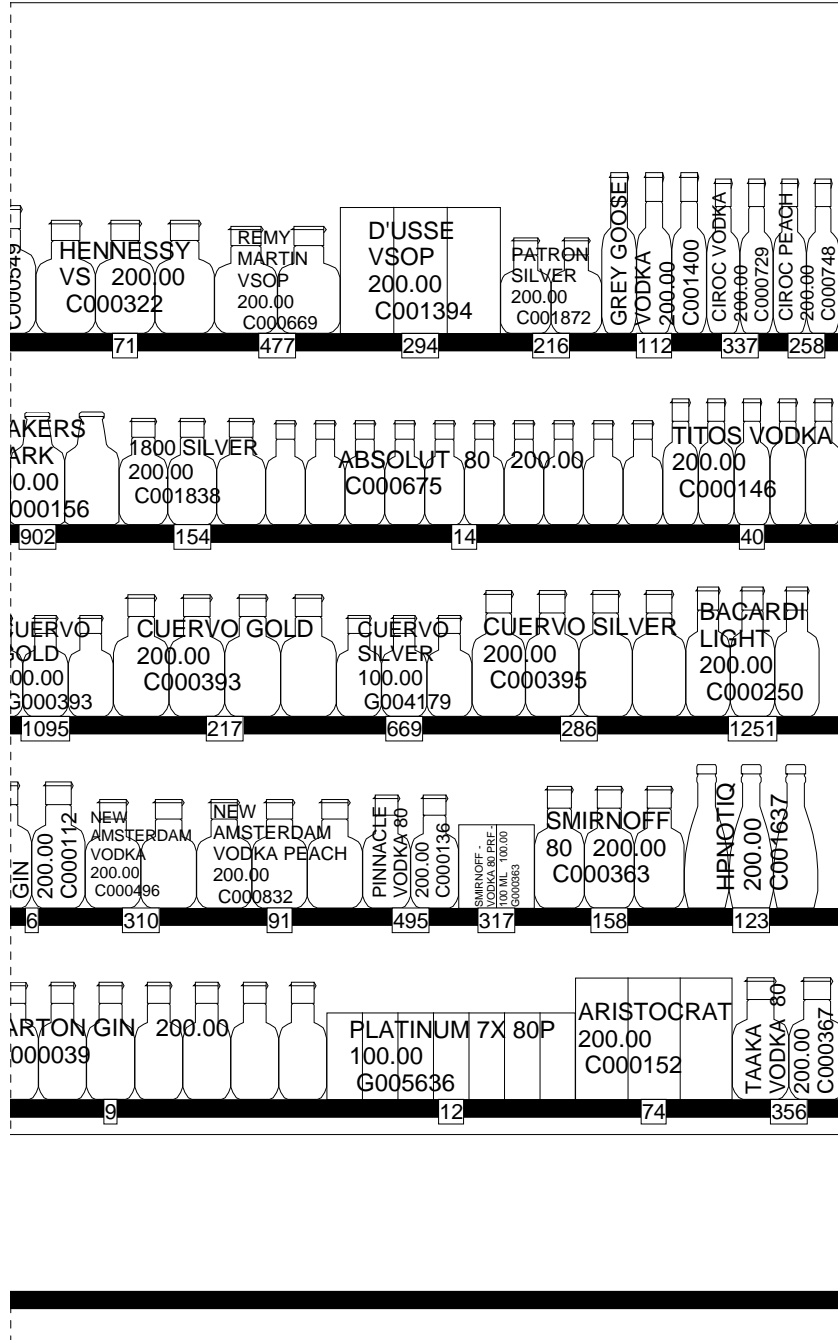

84

96

108

120

132

144

156

3/7/2024